

www.agilent.com

Basic Instruments

Selection Guide

Product and solution summaries
from Agilent's Web

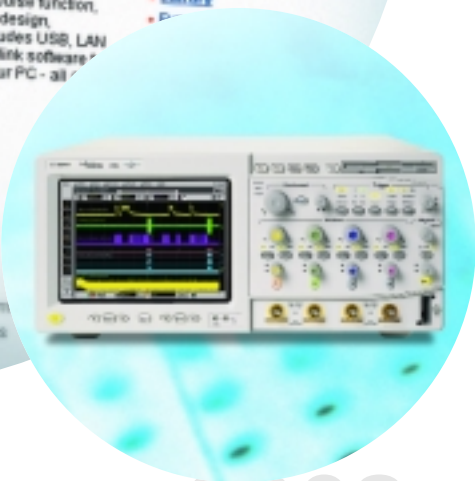
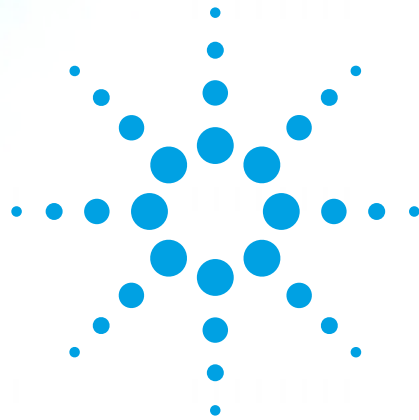

2003



Agilent Technologies

the right information, fast and easy

We've redesigned both this selection guide and the Agilent web site to help you find the information you need to choose and use test and measurement equipment successfully.

Step 1

Narrow your search

Browse the product families here in this selection guide. Use the key specifications and product highlights to identify equipment of interest. Learn about service and support options.



Step 2

Find the details

Visit the corresponding pages online to compare products, read in-depth product descriptions and see complete performance specifications.



New Products



Page 11.

The Agilent 33220A function/arbitrary waveform generator provides waveforms up to 20 MHz with the lowest distortion of any function generator in its class.



Page 26.

With the Agilent 54640 Series scopes, view simultaneous measurements on 2 analog and 16 logic channels. Advanced MegaZoom technology delivers fast, usable and affordable deep memory.

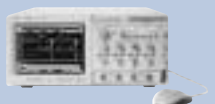

Page 30.

It's now easy to measure a combination of signal types and speeds all at once, including slow analog, fast digital or baseband RF with the 54830D Series mixed-signal oscilloscopes.



Page 38.

The Agilent Developer Network provides fast, convenient access to the information, tools and support that solve connectivity challenges.

Basic Instruments

Digital Multimeters	5
34970A Data Acquisition Switch Unit	6
3499 Switch Family	7
Frequency and Time Interval Counters	8
RF and Microwave Frequency Counters	9
Pulse/Pattern Generators	10
Function/Arbitrary Waveform Generators	11
DC Power Supplies and DC Electronic Loads	14
E3600 Series Basic DC Power Supplies	15
662X Multiple-output DC Power Supplies	15
601XA and 603XA Autoranging DC Power Supplies	16
65XX/66XX Performance DC Power Supplies	16
66000 Modular Power System	17
DC Electronic Loads	17

Service & Support

Test and Measurement Services	18
Engineering and Calibration Services	19

Digital Design & Debug Tools

Logic Analyzers Overview	20
Standalone Logic Analyzers	21
PC-hosted Logic Analyzers	22
Logic Analyzer Probing Solutions	23
Processor, Bus and FPGA Support	24
Oscilloscopes Overview	25
54600 Series Oscilloscopes	26
General Purpose Infiniium Oscilloscopes	27
Mixed-signal Oscilloscopes	30

Accessories

Oscilloscope Probes and Accessories	32
Test and Measurement Accessories	33

RF and Microwave Instruments

ESG Vector Signal Generator	34
ESA-E and ESA-L Portable Spectrum Analyzers	35
ENA Series RF Network Analyzers	36
EPM and EPM-P Power Meters	37

Test Software & Connectivity

Agilent Developer Network	38
T&M Programmers Toolkit, VEE, IntuiLink	39
GPIB Cards and Converters	40

Application Resources see page 2

Leasing, Rental and Financing Options see page 4

Country Contact Information see page 41

Ordering Information see Inside Back Cover

Instant access to application resources and information

With increasing demands on your time and the expectation to get more done with less, the right information can often make all the difference. Agilent offers a wide array of print, online and webcast resources to help you accelerate design verification, debugging and testing.

Application resources

- **Application Central:** The place to start, whether you want to brush up on the basics or explore advanced technologies and applications. www.agilent.com/find/appcentral
- **Wireless Central:** The latest on wireless standards, applications and products. www.agilent.com/find/wireless
- **Bluetooth™ & Wireless LAN:** From design tips to industry news. www.agilent.com/find/wireless
- **Aerospace/Defense:** Applications, technologies and new developments in security, surveillance and design. www.agilent.com/find/ad
- **Application Note Library:** Hundreds of application notes and technical papers covering virtually every test and measurement subject area. www.agilent.com/find/apps



Visit *Application Central* for quick access to print, online and multimedia resources that help with today's hottest technologies

- **Educator's Corner:** A unique site that helps instructors expose their students to contemporary engineering challenges. www.educatorscorner.com
- **Back to Basics:** Free training programs and resources covering RF, microwave, lightwave and digital. www.agilent.com/find/backtobasics
- **Agilent Measurement Solutions Newsletter:** Keep up-to-date on the latest in measurement applications, new products, training, events and seminars. www.agilent.com/find/solutions

Get the latest information and newest test skills

Cut through the clutter with timely updates on the test and measurement topics most important to you. The Agilent Email Update Service ensures that you get the latest information for making better use of Agilent equipment and helps keep your technical skills up-to-date with information on the latest technology advances.

Only the information you want, when you want it

Easily identify your specific interests from a selection of more than 100 product and application areas and specify the types of information you'd like to receive:

- **Support information** (such as new products and enhancements information/specifications, application information and technical notes on technologies and standards, tradeshows, events, and live/virtual seminars)
- **What's New** (including education/training and consulting services, firmware/software upgrades, and warranty, calibration and repair)

Total commitment to privacy

Agilent is proud to participate in the Better Business Bureau On-Line Privacy Program, and we adhere to all of the program's standards. We will never sell or rent your email address, nor will we share it with anyone without your consent. If you have any questions, please contact our privacy advocate via email at privacy_advocate@agilent.com.



Agilent Email Updates

www.agilent.com/find/emailupdates
Get the latest information on the products and applications you select.

A variety of support options at your fingertips

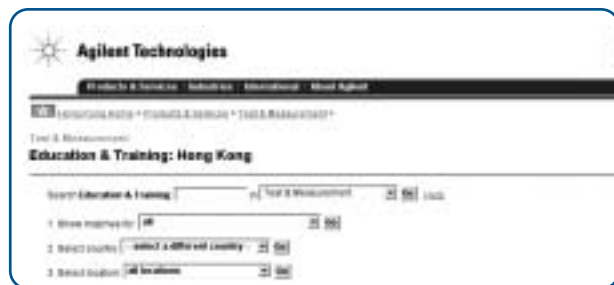

News, events and education

- **Education and Training:** Search course schedules and engineering curriculum programs.
www.agilent.com/find/education
- **Event Calendar:** Quick access to both Agilent and industry-wide seminars, classes and conferences.
www.agilent.com/find/events

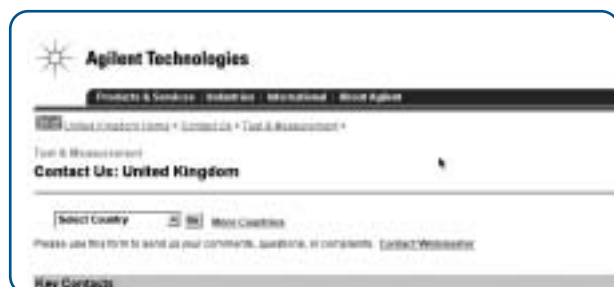

Sales and support

- **Contact Us:** From product selection to service and repair, find the people with the answers in your local area.
www.agilent.com/find/contactus
- **Technical Support:** Contact numbers and key technical support information for test and measurement products
www.agilent.com/find/techsupport
- **Financing Options:** Explore renting, leasing and financing options to get the most from your equipment budget.
www.agilent.com/find/buyalternatives
- **Refurbished Equipment:** Save up to half the cost of new equipment without sacrificing quality or support.
www.agilent.com/find/refurbished



Stretch your budget with creative purchasing options

Agilent Technologies offers a variety of ways to help you get the equipment you need, even if your budget isn't what it used to be.

Choose the option that meets your needs!
Cut your cost, risk, and time to market with Rent, Lease and Finance plans designed specifically for the high-tech industry.

- Rent**
For terms of less than 12 months, with fast delivery of the equipment you need
- Lease and Finance**
For terms of 12 months or longer, whether you want to lease or own

Featured Promotion



Divide by 12
Finance the purchase of selected Agilent products over 12 months, with no interest and no cash up front.

Rent, lease or finance to conserve capital

Take advantage of Agilent's newest solutions without large, up-front payments – and limit your exposure to technical obsolescence. Leasing or financing frees up capital for other investments, and the return on these investments can offset the cost of your lease. Fixed monthly payments simplify budgeting, too. For short-term needs, many of Agilent's newest products are available quickly through our Premier Rental Partners.

www.agilent.com/find/leasefinance.

Trade up to new technology in three easy steps...

1. Select the new equipment you want to purchase. Move up to new technology or over to a different product line with hundreds of qualifying instruments – like the ones featured below.
2. Identify and return the equipment you want to trade in. Eligible Product Categories.
3. Receive a credit toward your purchase of the new equipment. Contact us to determine the trade up value of the equipment you will trade in.

Trade Up



Capitalize on your investment in previous technology

Trade up to the latest technology

The Agilent Trade Up program has been expanded and automated to help you trade in underutilized or outdated equipment for credit toward the latest technology. Check out the extensive list of products from Agilent and other manufacturers that qualify for credits year round. And watch for special limited-time promotions, too.

Sign up for customized email updates to get early notice of trade-up promotions that match your equipment needs.

www.agilent.com/find/trade-up.

Search by Model Number

Search by Product Category

... Please Select a Product Category ...

View all Special Deals

- Download our complete Special Deals List (pdf)
- View all Refurbished Equipment**
- Download our complete Refurbished Equipment List (pdf)

Featured Deal



Discounts starting at 65% in our Clearance Sale
For a limited time only!

Get premium refurbished equipment – guaranteed to perform

Save up to half the cost of new equipment but get products that are guaranteed to perform the tasks for which they were manufactured. Agilent offers a broad inventory of premium equipment, much of it from our prior year's demo inventory. You get equipment that is refurbished by Agilent and sold with the same industry-leading warranty the products had when they were sold new. (For the majority of products, this means a three-year warranty.)

Inventory changes daily, so check back frequently. And click on 'Special Deals' to find deep discounts on specific models.

www.agilent.com/find/refurbished.

Learn more about all of these options and availability in your region by visiting www.agilent.com/find/buyalternatives or contact your local Agilent sales office.

Multi-function flexibility with laboratory accuracy at production-line speeds



Agilent digital multimeters measure DCV, ACV, resistance, frequency, and period with laboratory accuracy and system speed. They deliver dependable results and convenient features that minimize test and troubleshooting times.

34401A digital multimeter, 6½ digit: accuracy of 0.0015% for dc volts and 0.06% for ac volts. One or two button presses give you functions from dc volts

to frequency to dB and dBm. Advanced tests include limit checks, min/max/avg readouts and dc voltage ratios.

3458A digital multimeter, 8½ digit: up to 100,000 readings, 110 autoranges and more than 340 setup changes per second. Accuracy is 0.6 ppm for dc volts, 2.2 ppm for resistance, and 100 ppm for mid-band ac volts.

- **34401A:** 6½ digits of resolution at a 5½ -digit price
- **3458A:** up to 8½ digits of resolution, up to 100,000 readings per second
- **34420A:** nanovolt sensitivity with 7½ -digit precision
- **34970A:** 6½ digits of resolution, scan rates of up to 250 channels/second

34420A nanovoltmeter, 7½ digit: optimized for precision low-level measurements, with 7½ digit resolution and 1.3 nVrms/8 nVp-p noise performance.

34970A data acquisition switch unit, 6½ digit: three-slot mainframe with a built-in 6½ digit DMM. Choose from eight optional plug-in modules to create a compact data logger, full-featured data acquisition system or low-cost switching unit.

Selection Guide for Agilent Digital Multimeters				
	34401A	3458A	34970A ⁽¹⁾	34420A
Type	DMM 6½ Digit	DMM 8½ Digit	Data logger/scanning DMM 6½ Digit	Nanovolt /micro-ohm meter 7½ Digit
Basic measurements	dc & ac voltage, dc & ac current, 2 & 4 wire resistance, frequency & period			dc voltage, 2 & 4 wire resistance, low power resistance, ratio
Additional measurements	Continuity, diode test	3 modes of true RMS, digitizing	Scanning 20 to 60 2-wire channels	2 channels – ratio and difference
Temperature	N/A	Thermistor, RTD	Thermocouple, RTD, thermistor	Direct SPRT, RTD, Thermistor, thermocouple
dcV accuracy⁽²⁾ ±(% of reading + % of range)	0.0035 + 0.0005	0.0008 + 0.000005 (.0004 + .000005) ⁽³⁾	0.0035 + 0.0005	0.003 + 0.0004
acV accuracy⁽⁴⁾ ±(% of reading + % of range)	0.06 + 0.03	0.007 + 0.002	0.06 + 0.04	N/A
Math functions	Null, statistics, dBm, dB, limit test	Null, statistics, dBm, dB, limit test, scale, offset, filter, % error	Null, statistics, limit test, scale, offset	Null, statistics, dBm, dB, limit, test, scale, offset, filter, moving avg. filter

⁽¹⁾ Requires plug-in modules; 34970A has three slots and 8 modules to choose from (34901A, 34902A, 34903A, 34904A, 34905A, 34906A, 34907A, 34908A)

⁽²⁾ dcV accuracy; 1 yr, 10 V range

⁽³⁾ dcV accuracy with optional high stability reference (option 3458-002)

⁽⁴⁾ acV accuracy; 1 yr, 10 V range, 10 Hz to 20 kHz, (3458A 40 Hz to 1 kHz)

34970A Data Acquisition Switch Unit

Dedicated data-acquisition performance at PC plug-in prices

- **Three-slot mainframe, choice of 8-plug-in modules**
- **6½ digits (22 bits) of resolution**
- **Scan rates of up to 250 channels/second**
- **Includes BenchLink DataLogger software to configure and control tests, display results and move data for further analysis**



The Agilent 34970A consists of a three-slot mainframe with a built-in 6½ digit DMM. Choose from eight optional plug-in modules to create a compact data logger, full-featured data acquisition system or low-cost switching unit. On-module

screw-terminal connections eliminate the need for terminal blocks and a unique relay maintenance feature counts every closure on every switch for easy, predictable relay maintenance. Universal inputs let you measure 11 different functions

without the added cost or hassles of signal-conditioning accessories. It is easy to specify measurement functions channel by channel.

Selection Guide for Agilent 34970A Data Acquisition Control Unit Module

	Description	Speed (ch/sec)	Max voltage	Max current	Comments
34901A	20-ch. multiplexer (2/4-wire)	60	300 V	1 A	2 current channels (22 ch. total); built-in cold junction reference; connects to internal DMM
34902A	16-ch. multiplexer (2/4-wire)	250	300 V	50 mA	Built-in cold junction reference; reed relays multiplex inputs to internal DMM
34903A	20-ch. actuator/GP switch	120	300 V	1 A	Form C (SPDT) switches; no connection to internal DMM
34904A	4x8 matrix	120	300 V	1 A	2-wire, full crosspoint; no connection to internal DMM
34905A	2-GHz dual 1:4 RF mux, 50 Ω	60	42 V	0.7 A	1-GHz through provided BNC-to-SMB adapter cables; no connection to internal DMM
34906A	2-GHz dual 1:4 RF mux, 75 Ω	60	42 V	0.7 A	1-GHz through provided BNC-to-SMB adapter cables; no connection to internal DMM
34907A	Two 8-bit digital IO ports 26-bit, 100-kHz event counter Two 16-bit analog outputs	N/A	42 V 42 V ±12 V	400 mA 10 mA	Open drain Gated, selectable input threshold; Earth referenced; calibrated No connection to internal DMM
34908A	40-ch. single-ended multiplexer	60	300 V	1 A	Common low, no 4-wire meas. Built-in cold junction reference; connects to internal DMM
34970A	Data Acquisition/Switch Unit. Three-slot mainframe with internal 6½ digit DMM. GPIB, RS-232 and 50 K reading non-volatile memory with timestamp. Includes BenchLink Data Logger software.				

Customize a switching solution to meet your exact needs



- *"Perfect-fit" switching solution with no extraneous costs*
- *Scalable and flexible configurations with three mainframe choices*
- *Wide selection of plug-in modules for dc, RF, microwave and optical signals*

The Agilent 3499 Series of switches provide a wide choice of mainframes and switch modules. They represent a truly affordable, scalable platform for switching electronic and optical signals. All mainframe configurations of the Agilent 3499 can scan at rates up to 350 channels per second, or open/close 200 channels in

less than 0.1 second. Programmable control is provided via either RS-232 or GPIB.

The three mainframes provide up to a maximum of 80, 200, or 360 channels respectively in each mainframe. There are 27 different plug-in modules for switching electronic signals from DC

to 30 GHz with voltages to 1,000 V and currents to 8 A. Optical signals with wavelengths from 1,270 to 1,670 nm are switched with three different modules. All modules feature easy wiring for simplifying cabling and increasing reliability.

Selection Guide for Agilent 3499 Switch Family

	Description
Mainframes	Three mainframes provide an optimum fit today and a path for future expansion.
Multiplexer relays	Most useful for connecting instruments to a number of points.
RF and microwave switches	Nine different modules provide the best fit for satellite or communication signal switching.
General purpose relays	Various types of relay closures can be used for simple control or more complex ladder switching.
Matrix relays	Matrix switches offer the most flexibility for connecting multiple instruments to multiple points.
Digital I/O modules	Useful for monitoring digital states or controlling devices.
Optical multiplexers	Ideal for testing optical communications devices especially when electronic switching is also required.
Multifunction modules	Best for providing a smaller combination of multiplexer, matrix, digital I/O, or DAC outputs in a single module.
Mainframe model number	3499B 3499A 3499C

Count on precision, speed and versatility

- 2 channels, 10 and 12 digits/second frequency resolution and up to 150-ps time interval resolution
- Frequency ranges up to 12.4 GHz
- Pipelined architecture for higher measurement throughput



The Agilent 53131A/32A frequency counters perform a wide variety of time and frequency measurements at speeds up to 200 measurements per second via GPIB. Automated limit tests and extensive analysis features help you find detailed answers quickly. The 53131A offers 10 digits/sec frequency resolution and 500 ps time interval resolution up to

225 MHz on 2 channels (with optional 3, 5 or 12.4 GHz third channel). The 53132A offers the same measurement set and frequency coverage options with up to 12 digits/sec frequency resolution and 150 ps time interval resolution.

The value-priced Agilent 53181A RF counter provides 10 digits/sec frequency

resolution up to 225 MHz on one channel with an optional 1.5, 3, 5 or 12.4 GHz second channel.

Modulation domain analyzers can measure frequency and time interval measurements versus time.

Selection Guide for Agilent Frequency Counters and Time Interval Counters			
	53131A	53132A	53181A
Type	Universal (2 channel) ^[1]		RF (1 channel)
Measurements	Frequency, frequency ratio, time interval, period, rise/fall time, positive/negative pulse width, duty cycle, phase, totalize, peak voltage, time interval average, time interval delay		Frequency, frequency ratio (with optional ch. 2), period, peak voltage
Analysis	Automatic limit testing, math (scale and offset), statistics (minimum, maximum, mean, standard deviation)		
Frequency range (optional)	dc to 225 MHz (3, 5 or 12.4 GHz)	dc to 225 MHz (3, 5 or 12.4 GHz)	dc to 225 MHz (1.5, 3, 5 or 12.4 GHz)
Resolution (frequency, time interval)	10 digits/s, 500 ps	12 digits/s, 150 ps	10 digits/s, N/A

^[1] Channel 2 can only be used to make frequency, period, ratio, and voltage measurements – measurements on channel 1 and channel 2 are made sequentially.

Precision microwave counters with integrated power measurements



- Frequency ranges up to 46 GHz in a variety of channel configurations
- 53150 Series: frequency and power measurements with a single ultra-wideband microwave input (50 MHz up to 46 GHz)
- 53140 Series: DVM standard, improved power accuracy

The Agilent RF and microwave frequency counters provide high-performance frequency measurements from dc to 46 GHz.

The Agilent 53150 Series microwave counter with power measurement features

an ultra-wideband microwave input that covers the entire RF and microwave spectrum. An advanced sampler measures both frequency and power through a single connection.

The Agilent 53140 Series microwave counter/power meter/DVM offers the same measurement-set and frequency-coverage options with dc DVM, plus a true power meter for improved power accuracy.

Selection Guide for Agilent 53150 and 53140 Series CW Microwave Frequency Counters

	53150A	53151A	53152A	53147A	53148A	53149A
	CW Microwave Frequency Counters			Microwave Counter/Power Meter/DVM		
Frequency range Channel 1 (normal mode) Channel 2	10 Hz to 125 MHz 50 MHz to 20 GHz	10 Hz to 125 MHz 50 MHz to 26.5 GHz	10 Hz to 125 MHz 50 MHz to 46 GHz	10 Hz to 125 MHz 50 MHz to 20 GHz	10 Hz to 125 MHz 50 MHz to 26.5 GHz	10 Hz to 125 MHz 50 MHz to 46 GHz
Sensitivity Channel 1 (30 Hz to 125 MHz) Channel 2 (0.3 GHz to 12.4 GHz) (12.4 GHz to 18 GHz) (18 GHz to 20 GHz) (20 GHz to 26.5 GHz) (26.5 GHz to 40 GHz) (40 GHz to 46 GHz)	25 mVrms -33 dBm -33 dBm -29 dBm N/A N/A N/A	25 mVrms -33 dBm -33 dBm -29 dBm -25 dBm N/A N/A	25 mVrms -33 dBm -30 dBm -27 dBm -27 dBm -23 dBm -17 dBm	25 mVrms -33 dBm -33 dBm -29 dBm N/A N/A N/A	25 mVrms -33 dBm -33 dBm -29 dBm -25 dBm N/A N/A	25 mVrms -33 dBm -30 dBm -27 dBm -27 dBm -23 dBm -17 dBm
Power measurement accuracy Channel 1 Channel 2 (0 dBm to -20 dBm)	N/A ±1.5 dB	N/A ±1.5 dB (0.05 GHz to 20 GHz) ±2.0 dB (20 GHz to 26.5 GHz)	N/A ±1.0 dB (0.05 GHz to 12.4 GHz) ±1.5 dB (12.4 GHz to 26.5 GHz) ±2.0 dB (26.5 GHz to 46 GHz)			
Power meter specifications Frequency range Power range Power sensors supported Resolution Accuracy				100 kHz to 50 GHz, sensor dependent -70 dBm to +44 dBm, sensor dependent 8480 Series 0.01 dB in log mode, 0.1% of full scale in linear mode ±0.02 dB or ±0.5%. (Add power sensor linearity to spec for overall system accuracy)		
Voltmeter specifications Range Resolution Accuracy				± 50 Vdc 2 mV ± 0.25 % of reading ± 10 mV		
Math functions	Offset, averaging, cable loss compensation			Offset, averaging		

Tailor precision pulses, clocks and data patterns for digital testing throughout design and manufacturing

- **Pulse generation from 1 MHz to 3.35 GHz and 50 mV to 100 V**
- **Versatile serial data patterns and PRBS**
- **Jitter emulation for stress tests**
- **Precision timing for challenging synchronization and reference signals**



The Agilent family of pulse/pattern generators offers a large choice of models to fit your individual needs in digital design and manufacturing. With extensive control over transition time, amplitude and duty cycle you can tailor the unique signals for your application. The 81104A and

81110A are multi-purpose instruments for your everyday testing in digital design. For higher timing and data generation demands, the 81130A provides the enhanced timing specifications and pattern segmentation and looping features. When timing is critical, the new Agilent 81133A

and 81134A provide the high resolution, low jitter and very fast transitions needed. High performance and the capability to emulate jitter on clock and data signals make the 81134A ideal for stressed eye measurements.

Selection Guide for Agilent Pulse/Pattern Generators														
	8114A		81101A	81104A		81110A			81130A		81133A	81134A		
Channel model	N/A			81105A	81111A	81112A		81131A	81132A		N/A			
Signal types	Pulse		Pulse, Pattern, PRBS							Pulse, Pattern, Data, PRBS		Pulse, Pattern, Data, PRBS		
Key features	High power	Glitch free timing changes		Glitch free timing changes, multi level signals, analog channel add				Precision timing, pattern segmentation and looping; EXOR channel add		Delay modulation (jitter emulation), graphical user interface; LVDS levels				
No. of channels	1; single ended		1 or 2 single ended	1 or 2 single ended			1 or 2 differential		1		2 differential			
Frequency range	1 Hz – 15 MHz	1 MHz – 50 MHz	1 MHz – 80 MHz	1 MHz – 165 MHz	1 MHz – 330 MHz		1 kHz – 400 MHz	1 kHz – 660 MHz		15 MHz – 3.35 GHz				
Data pattern	NA	NA	16kbit/channel user defined; PRBS 2 ⁿ -1, n=7,8,...14 RZ, NRZ, DNRZ				65504bit/channel user defined; PRBS 2 ⁿ -1, n=7,8,...15 RZ, NRZ, DNRZ		8kbit/channel user defined; PRBS 2 ⁿ -1, n=5,6,7,...15,23,31 RZ, NRZ, DNRZ, R1					
Variable delay range	0.00 ns to 999 ms	0.00 ns – 999.5 s	0.00 ns to 999.5 s	0.00 ns to 999.5 s			0.00 ns to 3.00 µs		-5 ns to 230 ns					
Period RMS-jitter	0.03 % + 25 ps ⁽²⁾	0.01 % + 15 ps ⁽³⁾	0.01 % + 15 ps ⁽³⁾	0.001 % + 15 ps ⁽³⁾			0.001 % + 15 ps		<4 ps (1.5 ps typ)					
Amplitude range	1.00 V to 100 V ⁽¹⁾	100 mV to 20.0 V ⁽¹⁾	100 mV to 20.0 V ⁽¹⁾	100 mV to 20.0 V ⁽¹⁾	100 mV to 3.8 V		100 mV to 3.8 V	100 mV to 2.5 V		50 mV to 2.0 V				
Transition time range (10/90)	< 7 ns fixed	5.00 ns to 200 ms	3.00 ns to 200 ms	2.00 ns to 200 ms	800 ps or 1.6 ns selectable		800 ps or 1.6 ns selectable	500 ps typ. fixed		<90 ps fixed (in normal mode). Three settings for 60 ps-70 ps, 70 ps-80 ps and 80 ps-120 ps typ.				

⁽¹⁾ Depends on selected source impedance (all other values apply for 50 W source impedance into 50 W load)

⁽²⁾ 0.05 % + 25 ps in the 50 ns to 100 ns range

⁽³⁾ 0.01% + 15 ps without internal PLL as clock source

Value-priced generators with the versatility of custom waveforms



- 10 standard waveforms, with sine and square to 15 MHz, 20 MHz or 80 MHz
- Arbitrary waveforms with 40 MSa/s, 50 MSa/s or 200 MSa/s
- THD less than 0.04% and flatness as low as ± 0.1 dB

The Agilent 33120A, 33220A and 33250A function/arbitrary waveform generators give you 10 standard waveforms and the ability to create versatile arbitrary waveforms, with 12-bit or 14-bit resolution and a sample rate of 40 MSa/s (33120A), 50 MSa/s (33220A), or 200 MSa/s (33250A). In addition, the 33220A and 33250A can generate pulse waveforms with variable edge time.

Start with the signals a product is supposed to see, then add noise, harmonics, spurs and other extraneous signals to see how well it responds. Built-in modulation capabilities and both linear and log sweeps further expand your test possibilities without requiring additional genera-

tors. Plus, the external clock-reference timebase increases the frequency stability while letting you generate precise phase-offset signals, phase-lock to another 33120A, 33220A or 33250A, or to a 10 MHz frequency standard.

Selection Guide for Agilent Function/Arbitrary Waveform Generators

	33120A	33220A	33250A
Frequency range (sine, square)	15 MHz	20 MHz	80 MHz
Standard waveforms	Sine, square, triangle, ramp, noise, sin(x)/x, exponential rise and fall, cardiac, dc volts	Sine, square, pulse, triangle, ramp, noise, sin(x)/x, exponential rise and fall, cardiac, dc volts	Sine, square, pulse, triangle, ramp, noise, sin(x)/x, exponential rise and fall, cardiac, dc volts
Arbitrary waveforms	8 to 16,000 points	1 to 64 K points	1 to 64 K points
Sample rate	40 MSa/s	50 MSa/s	200 MSa/s
Modulation	AM (internal/external), FM (internal), FSK (internal/external), burst (internal/external)	AM, FM, PM, FSK, PWM, sweep and burst (all internal/external)	AM, FM, FSK, burst (all internal/external)
Sweep	Linear or logarithmic; up or down	Linear or logarithmic; up or down	Linear or logarithmic; up or down
External clock reference	Optional External lock range: 10 MHz \pm 50 Hz Internal frequency: 10 MHz	Optional External lock range: 10 MHz \pm 35 kHz Internal frequency: 10 MHz	Standard External lock range: 10 MHz \pm 35 kHz Internal frequency: 10 MHz
Connectivity (IntuiLink SW included)	GPIO/RS-232	GPIO, USB, LAN	GPIO/RS-232
Warranty	3 years	3 years	3 years

Generate pulses and patterns

With arbitrary waveform capabilities, a modern function generator can create just about any waveform as long as the pattern repeats before it runs out of memory.

The next time you are in the middle of a project and find that you need a pulse for testing, consider using a function generator before you conclude that you must use a dedicated pulse generator. The capabilities of function generators include various methods of generating pulses and patterns.

The most recent versions of function generators still create the typical sine, square, and triangle waveforms, and allow various modulation options. Some even have built-in modulation types such as AM, FM, PM, FSK, and PWM. But these new instruments go far beyond generating these typical outputs. With arbitrary waveform capabilities, a modern function generator can create just about any waveform as long as the pattern repeats before it runs out of memory. The arbitrary waveform capability allows creation of whatever you can load into the function generator's RAM.

You can also use arbitrary waveforms to generate a wide variety of custom pulses and patterns. Don't conclude that an arbitrary waveform must always be an analog

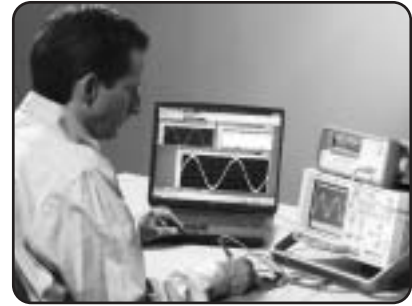

signal. At lower frequencies, you can load the function generator's RAM with values to create not just pulses, but also patterns of pulses. More information on this technique is available in the application note "Using a Function/Arbitrary Waveform Generator to Generate Pulses" found at www.agilent.com/find/apps.

And generate pulses by using the square wave output. By varying the duty cycle, you can establish the required pulse width. Even when the minimum duty cycle of the function generator is limited (often to about 20 percent), you may be able to use a burst mode to create low duty-cycle pulses (**figure 1**). This technique is discussed in the application note "How to Generate Low Duty-Cycle Pulses with a Function Generator" found at www.agilent.com/find/apps.

An even easier way to create a pulse is to use a function generator that includes built-in pulse generation capability. This allows you to specify a pulse in much the same way as you would with a dedicated pulse generator (**figure 2**).

Now easier to connect

One of the most important new capabilities of function generators is the ability to connect to a test system controller via GPIB, LAN, or USB. For example, the Agilent 33220A function generator

includes all three interfaces to ease system integration. Further, advances in tool capabilities move creating test programs into the familiar world of Microsoft® development tools without requiring you to use multiple development environments to get the job done.

...connect to a test system controller via GPIB, LAN, or USB.

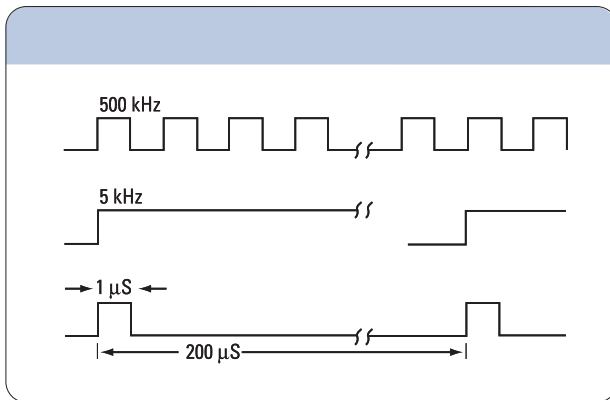

Figure 1. A graphical representation of burst rate, generating a 1 μs pulse with a 0.5 percent duty cycle.

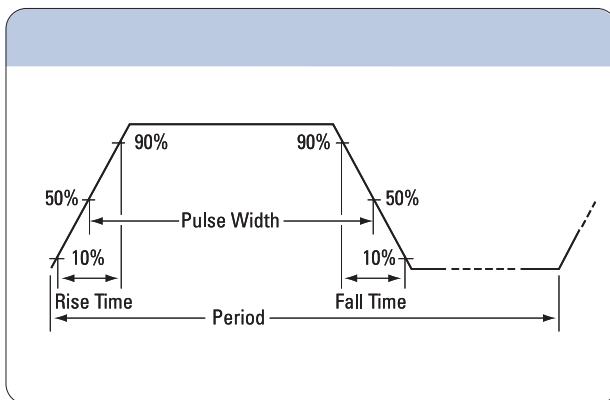

Figure 2. Pulse waveform parameters.

Microsoft is a U.S. registered trademark of Microsoft Corporation.

Power solutions that give you test results you can count on

- *Designed for the most rigorous applications*
- *Clean, stable, reliable power for a wide range of tests and measurements*
- *Extensive DUT protection features with proven reliability*
- *Single and multiple output/input models that cover a broad span of volt/amp/watt ratings for all your test needs*



Agilent’s one-box approach to power products improves your test results while cutting your costs, system complexity and rack size. Agilent specifies and guarantees performance for the entire one-box solution, so you can count on your test results.

Even Agilent’s least-expensive DC supplies offer low ripple and noise, with tight load and line regulation. Agilent’s high-precision products give you exacting control over power output levels, with accurate readback measurements to match.

Agilent engineers can save you time and money when you’re looking for new power supplies, with customized solutions for unique applications.

Selection Guide for Agilent Power Products		
Product family	Test advantages	Max. input/output power
6600-series performance single-output DC power supplies	Get clean, stable power while lowering system integration cost and overall test times.	40 W to 6,600 W
6620-series multiple-output DC power supplies	Multiple DC signals in minimal rack space, available in standard and high-accuracy models.	25 W to 80 W/output
66000 modular power system	Make the most of limited rack space by packing up to eight supplies into just 18 cm (7 in.) of rack space.	Up to 1,200 W (150 W/output)
E3600-series basic DC power supplies	Low cost, linear regulation with programmable single-, double- and triple-output supplies; high value, solid performance.	30 W to 200 W
6010, 6030-series autoranging DC power supplies	Flexible power solutions to test military, aerospace and other equipment across a wide range of operating points.	200 W, 1 kW
N3300-series electronic loads	Increase test throughput in high-volume manufacturing of DC power supplies and chargers.	Up to 1.8 kW (up to 600 W/input)

Quiet, stable DC power for low-cost manual and automated testing



- *Low noise and excellent regulation*
- *Front-panel programming and/or GPIB and RS-232*
- *Single- to triple-output models*
- *Convenient size for the R&D bench*

	E3610A E3611A E3612A	E3614A/5A E3616A/7A	E3620A	E3630A	E3631A	E3632A E3633A E3634A	E3640A/41A E3642A/43A E3644A/45A	E3646A/47A E3648A/49A
GPIB	No	No	No	No	Yes	Yes	Yes	Yes
# outputs	1	1	2	3	3	1	1	2
# ranges	2	1	1	1	1	2	2	1
V-range	Up to 120 V	Up to 60 V	0-25 V	Up to 20 V	Up to 25 V	Up to 50 V	Up to 60 V	Up to 60 V
I-range	Up to 3 A	Up to 6 A	0-1 A	Up to 2.5 A	Up to 5 A	Up to 20 A	Up to 8 A	Up to 5 A
Ripple-rms	200 μ V	200 μ V	350 μ V	350 μ V	350 μ V	<500 μ V	<1 mV	<1 mV
Power	30 W	48-60 W	50 W	35 W	80 W	120-200 W	30-80 W	60-100 W

For complete details, visit www.agilent.com/find/bi15am03

662X Multiple-output DC Power Supplies

Get high performance and save rack space with up to four outputs in a single box



- *Fast programming speed*
- *Low ripple and noise*
- *Extensive protection features for DUTs*
- *Easy to integrate into a system*

	6621A	6622A	6623A	6624A	6627A	6625A	6626A	6628A	6629A
GPIB	Yes	Yes	Yes	Yes	Yes	Yes	Yes	Yes	Yes
# outputs	2	2	3	4	4	2	4	2	4
V-range	Up to 20 V	Up to 50 V	Up to 50 V	Up to 50 V	Up to 50 V	Up to 50 V	Up to 50 V	Up to 50 V	Up to 50 V
I-range	Up to 10 A	Up to 4 A	Up to 10 A	Up to 5 A	Up to 2 A	Up to 2 A	Up to 2 A	Up to 2 A	Up to 2 A
Ripple-rms	500 μ V	500 μ V	500 μ V	500 μ V	500 μ V	500 μ V	500 μ V	500 μ V	500 μ V
Power	80 W/output	80 W/output	2 outputs at 40 W, 1 output at 80 W	40 W/output	40 W/output	1 output at 25 W, 1 output at 50 W	2 outputs at 25 W, 2 outputs at 50 W	50 W/output	50 W/output

For complete details, visit www.agilent.com/find/bi15bm03

601XA and 603XA Autoranging DC Power Supplies

Save space and cost: test at a wide range of V and I combinations with a single box

- Flexibility for subassembly test
- Optimal for military and aerospace applications
- Extensive protection features for DUTs
- Proven reliability



	6010A	6011A	6012B	6015A	6030A	6031A	6032A	6033A	6035A	6038A
 GPIB 	No	No	No	No	Yes	Yes	Yes	Yes	Yes	Yes
 Output voltage 	0-200 V	0-20 V	0-60 V	0-500 A	0-200 V	0-20 V	0-60 V	0-20 V	0-500 A	0-60 V
 Output current 	0-17 A	0-120 A	0-50 A	0-5 A	0-17 A	0-120 A	0-50 A	0-30 A	0-5 A	0-10 A
 Ripple-rms 	22 mV	8 mV	8 mV	50 mV	22 mV	8 mV	8 mV	3 mV	50 mV	3 mV
 Power 	1200 W	1064 W	1200 W	1050 W	1200 W	1064 W	1200 W	242 W	1050 W	240 W

For complete details, visit www.agilent.com/find/bi16am03

65XX/66XX Performance DC Power Supplies

Shorten test time and maximize throughput with performance DC power supplies

- Fast programming speed
- Low ripple and noise
- Fast protection features for DUTs
- Proven reliability



	6611C-6614C	6631B-6634B	6541A-6545A	6641A-6645A	6551A-6555A	6651A-6655A	6571A-6575A	6671A-6675A	E4356A	6680A-6684A	6690A-6692A
 GPIB 	Yes	Yes	No	Yes	No	Yes	No	Yes	Yes	Yes	Yes
 # ranges 	1	1	1	1	1	1	1	1	2	1	1
 V-range 	Up to 100 V	Up to 100 V	Up to 150 V	Up to 170 V	Up to 156 V	Up to 156 V	Up to 200 V	Up to 200 V	0-70 V 0-80 V	Up to 40 V	Up to 60 V
 I-range 	Up to 5 A	Up to 10 A	Up to 20 A	Up to 20 A	Up to 60 A	Up to 60 A	Up to 220 A	Up to 220 A	30 A	Up to 1000 A	Up to 440 A
 Ripple-rms 	500 µV	500 µV	<1 mV	<1 mV	<1 mV	<1 mV	<3.5 mV	<3.5 mV	2 mV	<3.4 mV	2.5 mV
 Power 	50 W	100 W	200 W	200 W	500 W	500 W	2000 W	2000 W	2000 W	5000 W	6600 W

For complete details, visit www.agilent.com/find/bi16bm03

Get greater throughput in less space with the flexible modular power system



- *8 power-supply outputs in one mainframe*
- *Increase throughput with LIST mode*
- *Easy to reconfigure*
- *Easy to integrate into a system*

	66101A	66102A	66103A	66104A	66105A	66106A
GPIB	Yes	Yes	Yes	Yes	Yes	Yes
Output voltage	0-8 V	0-20 V	0-35 V	0-60 V	0-120 V	0-200 V
Output current	0-16 A	0-7.5 A	0-4.5 A	0-2.5 A	0-1.25 A	0-0.75 A
Ripple-rms	2 mV	3 mV	5 mV	9 mV	18 mV	30 mV
Power	128 W	150 W	150 W	150 W	150 W	150 W

For complete details, visit www.agilent.com/find/bi17am03

DC Electronic Loads

Maximize throughput under real-life loading conditions



- *Decrease system development time*
- *Increase system flexibility and reliability*
- *Stable operation down to zero volts*
- *Single and multiple input*

	N3302A	N3303A	N3304A	N3305A	N3306A	N3307A	6060B	6063B
GPIB	Yes	Yes	Yes	Yes	Yes	Yes	Yes	Yes
Type	Module	Module	Module	Module	Module	Module	Single	Single
Input voltage	0-60 V	0-240 V	0-60 V	0-150 V	0-60 V	0-150 V	3-60 V	3-240 V
Input current	0-30 A	0-10 A	0-60 A	0-60 A	0-120 A	0-30 A	0-60 A	0-10 A
Power	150 W	250 W	300 W	500 W	600 W	250 W	300 W	250 W

For complete details, visit www.agilent.com/find/bi17bm03

Keep your equipment in peak operating condition

- *Solutions that help you increase equipment utilization*
- *Maximize your uptime goals*
- *Expand your strengths, minimize your weaknesses*
- *Solutions to get you over your business hurdles*

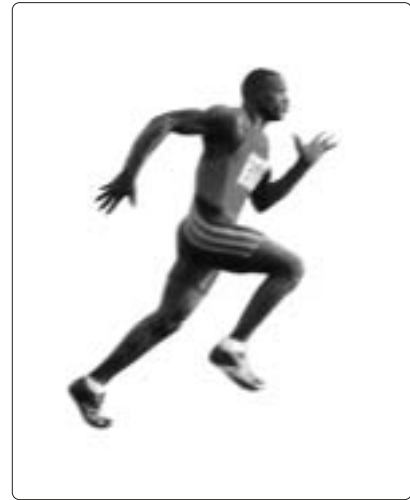

Agilent provides a complete range of services to ensure your instruments do the job they were designed to do and keep them performing for as long as you need them to. It's the Agilent Equipment Fitness Program, and just as regular exercise and checkups keep your body in good shape, regular calibration and equipment maintenance keep your equipment reliable and accurate allowing you to

focus on your business. It's one less thing to worry about.

Having the right information at the right time can pay for itself many times over. Agilent provides a full range of engineering services that are specifically designed to help you optimize the use of your Agilent products. Whether you need pace-setting advice or a collaborative

approach to improving test processes, you can team with Agilent Technologies to tailor a consulting solution to maximize every step of your product lifecycle.

From start to finish, the Agilent Fitness Program will ensure your equipment and the people who use it operate at peak condition.

Agilent Equipment Fitness Program Elements	
<p>Calibration Services – Measurement confidence is assured with our Fast-track, Selective and Inclusive Agilent Calibration services. On-site services such as VOSCAL are provided for the ultimate in convenience.</p>	<ul style="list-style-type: none"> • Measurement accuracy • Successful audits • Assured performance
<p>Warranty & Repair Services – With our expertise and worldwide capability, Agilent is the safe choice in ensuring your equipment is in the game at all times.</p>	<ul style="list-style-type: none"> • Peace-of-mind • Ongoing performance • Reduced risk
<p>System Uptime Solutions – Your test systems are assured the highest level of endurance and uptime with our Agilent Advantage System Uptime Solutions.</p>	<ul style="list-style-type: none"> • Uptime assurance • Proactive coverage • Balance uptime & cost
<p>Equipment Management Solution – Know your strengths and weaknesses with our suite of asset management tools and services.</p>	<ul style="list-style-type: none"> • Reduced downtime • Decreased cost of ownership • Total awareness
<p>Professional Consulting Solutions – Customized solutions designed and delivered by experts that know what it takes to win.</p>	<ul style="list-style-type: none"> • Expert knowledge • Tailored solution • Partner in success
<p>Engineering Services – Develop your team into star performers with the highest level of equipment knowledge and utilization.</p>	<ul style="list-style-type: none"> • Optimized equipment utilization • Efficiency • Get started faster

Reduce testing errors and minimize equipment down time



- **Accuracy** – OEM design and manufacturing knowledge means getting it right the first time
- **Reduced financial risk** by getting test equipment back in play faster
- **Worldwide service centers** mean Agilent is always your home team

Agilent Technologies provides an excellent factory warranty with all of its test and measurement equipment. It provides the peace-of-mind that today's high-tech industry requires. But don't let the game end there – Agilent can provide you with extended repair coverage, a repair agreement, or as-needed repair service at over 40 different customer service centers located around the globe.

Agilent Calibration combines the rigor and thoroughness of our high quality

calibration process with the flexibility of a modular approach – enabling cost savings while ensuring equipment is maintained at the highest level. With Agilent Calibration you can choose the package that suits the way you like to work and be confident in your testing quality. There are three forms of Agilent Calibration:

Fast-track – Best value, fast turnaround, charged separately for testing and adjustments, saving you money when your equipment is in specification.

Selective – We'll tell you if the instrument is out of specification and let you decide whether to pay to have adjustments done.

Inclusive – One price that includes the testing and any adjustments. In the Inclusive range are also higher-level services such as accredited, ANSI Z540, or ISO 17025.

 **For complete details, visit www.agilent.com/find/bi19am03**

Engineering Services

From startup to application solutions, Agilent engineering services accelerate your success



- **Get up and running quickly**
- **Optimize your equipment performance and utilization**
- **Maintain your competitive edge**
- **Expert coaching to enhance your application**

Services	Benefit description	Location	Breadth of offering
Start-up Assistance	Helps you get up and running with your test equipment as quickly as possible in your local environment	Provided remotely or at your site	Customized to your application or specific needs
Product Services	Provides continued engineering support for best optimization of your instrument		
Education and Training	Increases product expertise and keeps you abreast of emerging technologies		
Application Services	Combines your knowledge with our expertise to enable you to meet your application goals	Provided at your site	

 **For complete details, visit www.agilent.com/find/bi19bm03**

Fast, accurate answers throughout the design validation cycle

- *Wide range of logic analyzers to meet real-world debug challenges*
- *Straightforward triggering capabilities quickly identify problems*
- *Comprehensive microprocessor, bus and protocol specific support*
- *Easy signal access with robust family of probing solutions*



Agilent's logic analyzers help minimize your project risk by providing the most reliable, accurate data capture and the most complete view of system behavior.

A comprehensive family of products offers a variety of form factors, acquisition speeds, memory depths, channel counts, analysis and application-specific

protocol tools to create a solution that will meet your toughest digital-debug needs.

Selection Guide for Logic Analyzers					
	Modular systems	Standalone logic analyzers		PC-hosted logic analyzers	
	16700 Series <i>(see www.agilent.com/find/16700)</i>	1680 Series <i>(see page 21)</i>	1670 Series <i>(see page 21)</i>	1690 Series <i>(see page 22)</i>	E9340A LogicWave <i>(see page 22)</i>
Form factor	Modular systems offer the most measurement flexibility and highest performance. Either built-in color touch screen (12.1 inch) or external monitor.	Fixed configuration offers a small footprint, mobility, with a built-in color display.		Fixed configuration, hosted by a desktop or laptop PC offers compact size at a low price.	
Typical applications <small>(includes but is not limited to)</small>	<ul style="list-style-type: none"> • Multiple processor/bus analysis • Timing and state analysis • Single-ended and differential signal acquisition • Inverse assembly and source code correlation • System performance analysis • Signal integrity validation • Stimulus and analog parametric measurement • Application-specific protocol tools 	<ul style="list-style-type: none"> • Single processor/bus analysis • Timing and state analysis • Single-ended signal acquisition • Inverse assembly 	<ul style="list-style-type: none"> • Multiple processor/bus analysis • Timing and state analysis • Single-ended signal acquisition • Inverse assembly • Optional stimulus or analog parametric measurement 	<ul style="list-style-type: none"> • Single processor/bus analysis • Timing and state analysis • Single-ended signals • Inverse assembly 	<ul style="list-style-type: none"> • Single processor/bus analysis • Timing and state analysis • Single-ended signals
Maximum high-speed timing	4 GHz timing at 64 K depth	N/A	N/A	N/A	N/A
Maximum state clock	1.5 Gb/s	200 MHz	150 MHz	200 MHz	100 MHz
Maximum timing sampling rate	1.2 GHz	800 MHz	500 MHz	800 MHz	250 MHz
Maximum channels	8,160 (68 and 102 channel modules)	136/102/68/34	136/102/68/34	136/102/68/34	34
Maximum memory depth	128 M	4 M	4 M	4 M	128 K
Additional considerations	Probes and accessories, wide variety of processor and bus and FPGA solutions, emulation probes, E5904B trace port analyzers, integrated logic analyzer and scope solutions.				

Faster insight with intuitive logic analysis

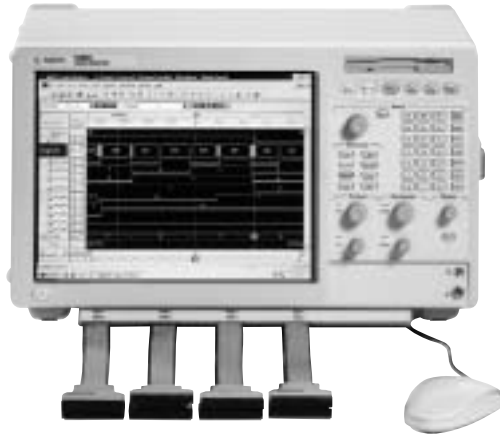

- Meet your application and budget needs by selecting from a variety of configurations that range from 34 to 136 channels
- Capture your signal in real time with 800-MHz timing analysis and 200-MHz state analysis
- Gain broader insight into system behavior with up to 4 M deep memory
- Save time by gaining instant insight from the award-winning single-screen operation, intuitive triggering, and familiar Windows® interface

Standalone logic analyzers extend Agilent's measurement reliability and accuracy to a portable instrument. The fixed configuration and small footprint also deliver excellent price performance.

These products are ideally suited for individuals and teams working on hardware debug, parametric and mixed-signal testing and complex debugging with deep memory. A robust product offering

enables you to select the model that meets your needs and fits your budget.

Selection Guide for Agilent Standalone Logic Analyzers

	1680 Series				1670 Series			
	1680A/1680AD	1681A/1681AD	1682A/1682AD	1683A/1683AD	1670G	1671G	1672G	1673G
Channels	136	102	68	34	136	102	68	34
Maximum state clock	200 MHz				150 MHz			
Maximum timing sampling rate (half/full channels)	800 MHz (1.25 ns)/400 MHz (2.5 ns)				500 MHz (2 ns)/250 MHz (4 ns)			
Maximum transitional timing rate	200 MHz				N/A			
Maximum memory depth (*half/full channels)	168XA Series: 256 K – State, 1 M/512 K – Timing*, 1 M – Transitional				128 K / 64 K – standard* 512 K / 256 K – option 001* 4 M / 2 M – option 002*			
	168XD Series: 1 M – State, 4 M/2 M – Timing*, 1 M – Transitional							
Display	12.1 inch (diagonal) color flat panel				8.4 inch (diagonal) color flat panel			
Additional capabilities	Time-correlation to external Infiniium 54800 Series oscilloscope, e-mail on trigger, offline analysis, remote programmatic control via COM				2 channel, 500 MHz integrated oscilloscope (option 003) OR 32 channel, 100/200 MHz, 256 K deep integrated pattern generator (option 004), remote programmability			

Windows is a U.S. registered trademark of Microsoft Corporation.

Intuitive usability with ultimate portability at a breakthrough price

- *Achieve complete mobility with the compact size and a connection to a laptop PC*
- *Capture your signals in real time with 800-MHz timing analysis and 200-MHz state analysis*
- *Select from a variety of configurations that range from 34 to 136 channels*
- *Gain broader insight into system behavior with up to 4 M deep memory*
- *Carry out debug work in the familiar PC environment*



Agilent Technologies PC-hosted logic analyzers have small footprints and fixed configurations that provide the lowest price for high-performance logic analysis.

They also offer superb reliability and accuracy. Their compact size and ability to connect to a laptop PC makes them an ideal solution for use at remote sites.

They're also ideal for individuals and teams working on hardware debug, parametric and mixed-signal testing and complex debugging with deep memory.

Selection Guide for Agilent PC-hosted Logic Analyzers					
	1690A/1690AD	1691A/1691AD	1692A/1692AD	1693A/1693AD	E9340A LogicWave
Channels	136	102	68	34	34
Maximum state clock	200 MHz				100 MHz
Maximum timing sampling rate (half/full channels)	800 MHz (1.25 ns)/400 MHz (2.5 ns)				250 MHz (4 ns)
Maximum transitional timing	200 MHz				N/A
Maximum memory depth (*half/full channels)	169XA Series: 256 K – State, 1 M/512 K – Timing*, 1 M – Transitional				128 K
	169XAD Series: 1 M – State, 4 M/2 M – Timing*, 1 M – Transitional				
Additional capabilities	Time-correlation to external Infiniium 54800 Series oscilloscope, e-mail on trigger, offline analysis, remote programmatic control via COM				N/A

Connections you can count on



- *Easily connect with reliable, electrically and mechanically unobtrusive probing solutions*
- *Gain access to individual, widely dispersed signals*
- *Choose from a robust selection of general-purpose and high-speed probes*

Accurate measurements start with reliable probing. Agilent Technologies offers a wide variety of probing accessories that

support general-purpose and application-specific measurement needs. The probes are reliable and electrically and mechani-

cally unobtrusive making it easy to connect your Agilent logic analyzer to your system under test.

Selection Guide for Agilent Logic Analyzer Probing Solutions ^{[1], [2]}

	01650-61608	01650-63203	E5346A	E5339A	E5351A	E5385A
Probe type	General-purpose flying-lead set	Medium-density probe	High-density probe for 38-pin Mictor connectors		High-density probe for 38-pin Mictor connectors	High-density probe for 100-pin Samtec connectors
Application	Flexible connection to individual signals	Quick connection to many channels in a small footprint				
Channel support	17	17	34	34	34	34
Supported signal types	Single-ended clock, single-ended data					
Maximum data rate	Equivalent to the logic analyzer data rate the probe is attached to.					

^[1] For more information on specific solutions, refer to Probing Solutions for Agilent Logic Analysis Systems, found at www.agilent.com/find/logic_analyzer_probes

^[2] All probes have isolation networks located at the probe tip except the E5351A, which requires isolation networks placed on the target.

Save time with customized measurement support

- **Quickly and reliably connect to your device under test**
- **Support available for comprehensive list of industry-standard processors and buses**
- **Display processor mnemonics or bus cycle decode**

Agilent Technologies and our partners provide an extensive range of quality tools that offer non-intrusive, full-speed, real-time analysis and processor execution control to accelerate your debugging process.

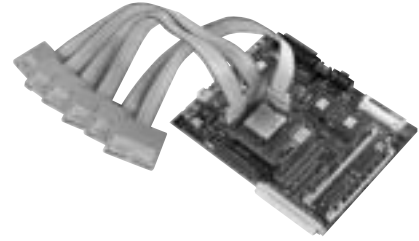

Agilent and Third-Party Processor Support	
Device manufacturer/ architecture and name	Inverse assembly/probing support
Actel	ACT 1280
Altera	EPM5192-P
AMD	186CC 186/188 EM/ES
Analog Devices	ADSP 21xx
ARM®/9TDMI	ARM7, ARM7-Thumb, ARM9, ARM9-Thumb
GTE	65816
IBM PPC 4xx IBM PPC 6xx IBM PPC 7xx	PowerPC 403/405/601/603/740/750/750Cxe
IDT	R3041/51/52/81/82,R4600/4700, R4640/50, R5000, R32364, R36100, RC32332/4/55, RC64474/4574, RC64475/4575
Intel® Pentium®, Pentium w/ MMX Intel Pentium Pro, II, III, & Celeron™	8080, 8085, 8031/51, 8086/8, 80x86, 80200, Celeron Pentium, Pentium II, Pentium III, Pentium II Xeon, Pentium III Xeon, Pentium 4, Xeon, Strong ARM-110, IXP1200, Itanium 2, IXP2500
Motorola PPC 6xx Motorola PPC 7xx Motorola MPC 8xx Motorola MPC 74xx Motorola MPC 82xx Motorola M CORE	68000/08/10, 680x, 68HC11, 68HC12, 68020, 68030, 68040, 68060, 68302, 68331/2/4/5, 68360 68340, PowerPC 555/565, 601/603, MPC740/745/750/755, MPC 7400/10/40/41/45/50/51/55, MPC 801/823/850/855/860/862, 860 ESAR, MPC 8240/45/55/60/64/65/66, M*CORE, DSP 56xxx, 88xxx
National	NS32016, HPC16003/4/64
NEC	7810/11, V25, V830, VR4100, VR4200, VR4300, R5000, R5432, R5464
NKK	NR46xx, NR4700
PACE	P1750
QED	5230/31, 5260/61, 5270/71, 7000
Rockwell	6502
Siemens	80C165/166/167, 80C5xx, RC1765, TC1775 (TRICORE)
Texas Instruments	320Cxx, 320C20x, 320C24x, 320C54x, 34010, 370CXX, 320C62XX
Xilinx	XC4xxx
Zilog	Z80, Z180, Z8001/2

ARM7TDMI is a trademark of ARM Limited.
Intel and Pentium are registered trademarks and Celeron is a U.S. trademark of Intel Corporation.
Rambus is a trademark of Rambus Inc.

Agilent and Third-Party Bus, Protocol or FPGA
AGP2X, AGP4X, AGP8X
CAN
CSIX
PC 133,DDR, DDR 200, DDR 266, DDR I-400, DDR II
Fibre Channel
Firewire (IEEE 1394)
Gigabit Ethernet (TBI)
GMII
HyperTransport
I ² C
InfiniBand x1, x4, x12
ISA
JTAG (IEEE 1149.1, 1149.5)
MPEG-2
PC 100/ 133 DIMM
PCI CardBus
PCI-EIO
PCI Express
PCI Mezzanine
PCI/EXT-32/64
POS-PHY L1 – L3
RAMBUS®
RapidIO
RS-232, RS-449
SCSI, Ultra SCSI, SCSI LVD
Serial ATA
SIMM, DIMM
SPI-4.2
USB 1.1, USB 2.0
Utopia
VME 64
VXI
Xilinx: Virtex, Virtex – E, Virtex II, Virtex II Pro, Spartan – II, Spartan –II E

Oscilloscopes for every budget and application need



- *Real-time oscilloscopes with bandwidths from 60 MHz to 1 GHz*
- *Unique mixed-signal scopes with integrated oscilloscope and logic-analysis features*
- *MegaZoom technology for fast and deep memory all the time*
- *High-definition displays with nearly twice the normal horizontal resolution*

Accelerate your troubleshooting

Agilent oscilloscopes are designed to help you accelerate the troubleshooting process. Based on input from customers around the world, Agilent has engineered features and unique capabilities that will

enable you to keep pace with the rapid changes in technology, yet are easier to use than most competitive products. The result is you spend more time troubleshooting your design and less time fighting your oscilloscope.

Probes and accessories

Agilent offers numerous probes and accessories to optimize oscilloscope performance. For information on probes for the mixed-signal and Infiniium general-purpose oscilloscopes, see page 32.

Selection Guide for Agilent 60 MHz to 1 GHz Oscilloscopes

	Mixed-signal	Portable	Infiniium general-purpose
Bandwidth	60 MHz to 1 GHz	60 to 500 MHz	600 MHz to 1 GHz
Channels	2+16 and 4+16	2 and 4	2 and 4
Sampling speed	Up to 4 GSa/s	200 MSa/s and 2 GSa/s	Up to 4 GSa/s
Memory	Up to 16 M	Up to 8 M	Up to 16 M
Description	A 16-channel timing analyzer is seamlessly integrated into a full-featured scope for debugging complex mixed-signal designs.	Low-cost scopes for the lab, the field, or the classroom with high-definition display, flexible triggering, and MegaZoom deep memory technology.	Lab scopes with unmatched usability and MegaZoom deep memory.

Comprehensive measurement tools at budget prices

- Choose from bandwidths ranging from 60 to 500 MHz
- Troubleshoot complex designs with responsive MegaZoom deep memory
- Reveal subtle details that the typical scope won't show, with a patented high-resolution display
- Take advantage of powerful triggering feature set
- Pick a compact, lightweight scope that's ideal for benchtop, field, or classroom settings

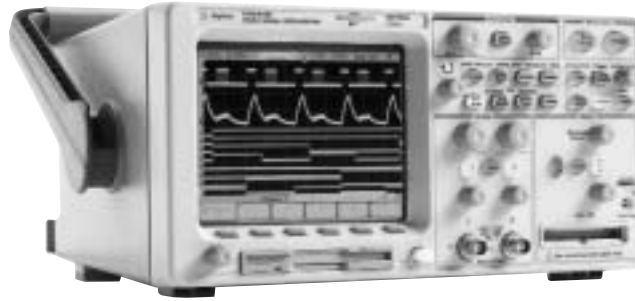

Selection Guide for Agilent 54600 Series Oscilloscopes					
	54642A	54641A	54624A	54622A	54621A
Bandwidth	500 MHz	350 MHz	100 MHz	100 MHz	60 MHz
Channels	2	2	4	2	2
Maximum memory	8 M	8 M	4 M	4 M	4 M
MegaZoom	Yes	Yes	Yes	Yes	Yes
Special features	Ease-of-use features such as dedicated controls for each channel, autoscale, and built-in help keep you focused on your test, instead of your test tools. Each of these scopes has a full triggering feature set with serial triggers, pulse width, and TV. Automatic and cursor measurements provide critical waveform characterization. MegaZoom deep memory and Agilent's unique high-resolution display show you exactly how your circuit is performing.				
Description	The personal lab scope for professionals needing high-bandwidth measurements at an affordable price. MegaZoom allows high-fidelity viewing of your fastest signals while viewing a full cycle of the system.	With 350 MHz bandwidth and 1 ns rise time, this is the scope for high-speed applications on a limited budget. This is the lowest-cost deep-memory scope to offer 1 ns performance.	Four full channels of MegaZoom deep memory make this the ideal scope for power electronics, electromechanical, and bio-physical applications. Each of the four channels has its individual dedicated control knobs for simplified operation.	The personal scope for professionals working with less than 50 MHz logic devices. Rich triggering and measurement capabilities make it an ideal lab scope for many applications.	Lowest-cost deep memory in the market. Ideally suited for electromechanical and education labs. Easily view your most demanding signals with MegaZoom and a high-resolution display.

Advanced troubleshooting, intuitive operation



- Choose from bandwidths up to 1 GHz, sample rates up to 8 GSa/s and memory depths up to 16 M points
- Simplify measurement setup with familiar Windows-based graphical user interface and analog-like front panel
- Find answers quickly with advanced help system
- Share measurement resources with LAN connectivity
- Free hands for probing with VoiceControl option (English only)

Agilent's Infiniium oscilloscopes combine ease-of-use and the right specifications with a broad feature set to help you get

your job done faster. If you are tired of spending 80 percent of your lab time fighting your instrumentation and only

20 percent making meaningful measurements, Infiniium is the scope for you.

Selection Guide for Agilent 54830B Series Infiniium Oscilloscopes

	54832B Infiniium	54831B Infiniium	54830B Infiniium
Bandwidth	1 GHz	600 MHz	600 MHz
Channels	4	4	2
Max sampling	4 GSa/s	4 GSa/s	4 GSa/s
Max memory	Up to 16 M	Up to 16 M	Up to 16 M
MegaZoom	Yes	Yes	Yes
Special features	11 trigger modes isolate circuit problems. 12 voltage, 11 time measurements, 14 waveform math functions, 7 eye diagram measurements, and 8 histogram measurements allow full circuit characterization.		
Description	The scope for projects where edge speeds are in the nanosecond range. Four deep MegaZoom channels show all the details.	Four channels of 16 M deep MegaZoom and Infiniium's ease of use bring your critical measurements into view.	When you need more than 500 MHz with the power of Infiniium at a budget saving price, this scope will fit your needs.
Notes	Standard memory is 4 M, options available for up to 16 M. Option 100 Communications Mask Test Kit and Option 200 VoiceControl apply to all Infiniium models.		

Advanced MSO triggering for digital system debugging

The subsystems being used in today's embedded systems have necessarily increased in complexity in order to achieve the levels of performance required of them. Complex memories such as SDRAM and DDR-SDRAM and complex internal buses such as PCI are mature, stable, and inexpensive, and are very attractive for use in embedded systems. However, even though they are reliable it is not reasonable to assume that you can just connect these subsystems together and end up with a working system.

To develop digital systems containing these complex subsystems, you need tools that allow you to quickly and easily verify the signal integrity of all signal paths. In particular, you need a method of viewing the analog nature of the digital signals and a method to accurately trigger on the complex signals controlling these subsystems.

A sequence often used to verify a digital system for its initial power up is to first make sure that the proper power is getting to each component. The second step is to verify functionality by checking that the appropriate signals are being generated. Once these basic checks are completed, the next step is to verify timing and signal integrity.

The key to timing and signal integrity verification is to isolate the different memory or bus cycles. An eye diagram, which is created by acquiring many traces and building a display that retains each signal, readily shows this (**Figure 1**). A clean eye diagram with a wide-open center demonstrates that all of the signals transition at nearly the same place and none of the signals wander into the center of the eye. If a timing or signal integrity problem exists, it will often become apparent as a trace inside the eye.

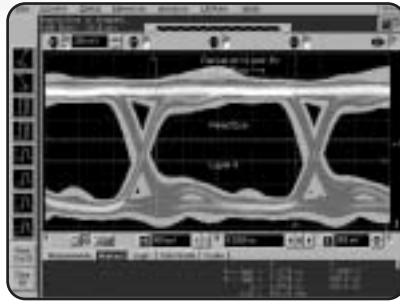

Figure 1. An eye diagram readily shows if timing or signal integrity problems exist.

Triggering for an eye diagram

Before you can create useful measurements such as an eye diagram, you have to be able to trigger an oscilloscope at the exact moment in time required to view the signal. Twenty years ago, memories were much simpler. They had simple address and data lines along with a few control lines, typically only a chip select and a write enable. You could easily check the integrity of the address and data signal paths with a four-channel oscilloscope.

The memories of today must perform some minor miracles to keep up with the incredible data rates expected of them. Part of the tradeoff to using high-speed memory such as SDRAM or DDR-SDRAM is a much more complex interface. There are many control lines instead of just a few and as a result, the 4-channel oscilloscope is no longer able to trigger itself at the appropriate moment to evaluate signal integrity.

For example, while turning on a DDR-SDRAM-based subsystem of an upcoming computer, an engineering team observed an ECC error on memory reads. Initially, they suspected a signal integrity problem on one of the data bits and decided to use an MSO to investigate. In order to make the required eye diagram measurement, they needed to trigger on a combination of memory control signals.

A memory read occurs when RAS is high, CAS is low, WE is high, CS is low, and the clock is going high. They had no dedicated connector on the board so they soldered 5 short 32-gauge wires onto the control signals.

Using an MSO

Debugging this type of system requires a mixed-signal oscilloscope (MSO). An MSO provides 2 or 4 channels or analog acquisition seamlessly integrated with 16 logic timing channels. The five logic signals (RAS, CAS, WE, CS, and clock) were connected to the logic inputs and the trigger was set to the appropriate pattern. When the system was conducting a DDR-SDRAM read operation, the digital lines triggered the scope.

As shown in **Figure 2**, the data line that was expected to be faulty during this debug session actually worked properly and the intermittent problem being tracked down was not caused by a signal integrity problem here. In a very short time, the signal integrity of this data line was checked and ruled out as a cause of the error.

The PCI bus is another example of a complex subsystem that is commonly used as it is inexpensive and stable. The PCI bus is very complex; its specification alone is over 300 pages. It has twelve different cycles. Besides the four command lines, there are six control lines, two error signals, two arbitration signals, a clock, and a reset line. To further complicate matters, many embedded systems use multiple PCI buses and PCI bridges.

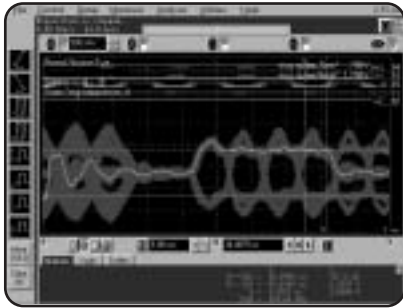

Figure 2. The eye diagram of a data line that was suspected of being faulty shows clean signals, so a signal integrity problem on this data line can be ruled out as the cause of a memory error.

Tracking down PCI woes

As another case study, an engineering team was developing a piece of test equipment that included multiple PCI buses. During environmental testing, near the end of the product development cycle, they observed intermittent system crashes that happened anywhere from once an hour to once a day.

The system was crashing during writes to registers on a custom ASIC. This operation occurred across three PCI buses. All the engineers knew was that the write was never getting acknowledged. They were able to easily connect a logic analyzer to Bus 1 and Bus 2, but not to Bus 3 as it was a BGA-to-BGA routing.

A deep-memory logic analyzer with two PCI bus preprocessors was used to follow the signals to the ASIC, and an MSO was used to look at the control signals of Bus 3. The logic analyzer was set to trigger on multiple retries associated with the lock-up. This led the team to determine that the lockup was occurring when the ASIC on Bus 3 was the master and was DMAing to the CPU while the CPU was attempting to write at the same time. So the failure was caused during a "bus turnaround."

Special software was written that dramatically increased the bus turnarounds, so that the lockup occurred in minutes instead of hours. Now that the team was able to recreate the failure at a more reasonable frequency, the MSO was used to isolate the first PCI bus cycle after a bus turnaround. The analog inputs of the MSO were used to verify the signal integrity of clock and control lines.

Zeroing in on the cause

This led to finding some address-dependent coupling on the clock to device 1 on Bus 3 (**Figure 3**). The offending trace was drilled out and temporarily replaced by a blue wire, removing the coupling, the address errors, and the lockups. After the most probable source of the coupling was identified, the board was laid out again and the problem was fixed.

It is possible to create a trigger without an MSO when debugging these complex subsystems. You can attempt to create special test software to help isolate cycles, create triggers in your hardware design, connect logic devices to the system to combine the signals for a trigger, or try to use the trigger output of a logic

analyzer. However, it is much more efficient to use tools that provide the triggering capabilities you need without having to resort to time-consuming, error-prone methods or other instruments to provide the trigger and uncover the problem, enabling you to focus on finding a solution.

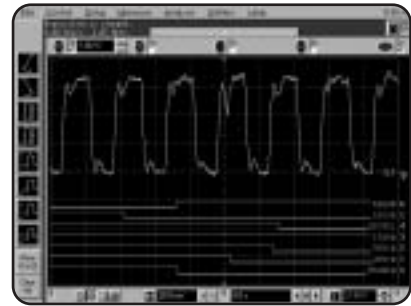

Figure 3. Address-dependent coupling can be seen interfering with the clock signal in this PCI bus-based system.

When you are debugging a system and you think the problem may be related to signal integrity, you don't want to have to waste time getting to the point where you can look at the signals. Without a tool such as an MSO, you may tend to delay checking signal integrity as long as possible when it takes a long time to set up the test. With an MSO, the time it takes to set up the trigger and check out the signals is so short that it will be one of the first things you check, as it should be.

Troubleshoot mixed-signal circuits quickly with simultaneous views of analog and digital

- Choose from bandwidths ranging from 60 MHz to 1 GHz
- View 18 to 20 time-aligned scope and timing channels simultaneously
- Troubleshoot mixed analog and digital designs with responsive MegaZoom deep memory
- Reveal subtle details that the typical scope won't show with a patented high-resolution display
- Take advantage of standard serial triggering including I²C, SPI, CAN frame and USB frame



More channels, more memory, more triggering

With the increasing digital content in today's designs, it is often difficult to capture enough channels simultaneously with a traditional 2- or 4-channel scope. To further complicate matters, the analog and digital sides are often operating at drastically different speeds.

Now you can capture, display and analyze a variety of signals in one acquisition on one instrument screen, helping you focus more quickly on tough design problems. With mixed-signal scopes, a 16-channel timing analyzer is seamlessly integrated into a full-featured scope. It's now easy to measure a combination of signal types and speeds all at once, including slow analog, fast digital, or baseband RF.

MegaZoom memory

MegaZoom memory technology is fast and deep, so you can capture a full cycle of your device's operation with the resolution needed to view critical intervals of the highest speed signals. MegaZoom is available at all times and does not require a special operating mode.

See More Serial Triggering

The Agilent 54620/40 Series oscilloscopes deliver some powerful triggering capabilities for R&D engineers responsible for serial communication designs:

- Serial Peripheral Interface (SPI). Specify the number of data bits to be transferred and the bit pattern of interest to trigger on.
- Basic Universal Serial Bus (USB). Synchronize the scope to the start or end of USB packets transmitted across the bus. Supports USB 1.1 specifications for low speed (1.5 Mb/s) and full speed (12 Mb/s).
- I²C. An extended I²C triggering capability includes a restart trigger, a missing acknowledge trigger, 10-bit write, and EEPROM read.
- Controller Area Network (CAN). Synchronize the scope acquisition to the start of CAN frames transmitted across the bus and correlate the results with other operations and signals.

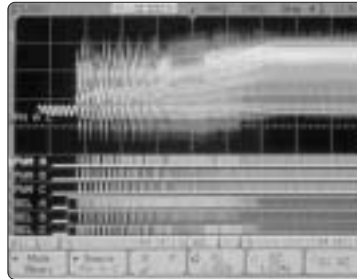
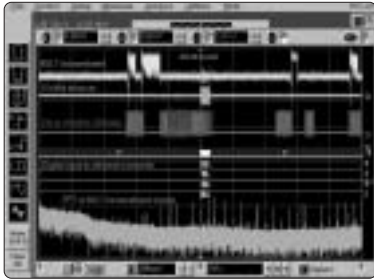

MegaZoom deep memory allows you to capture a full cycle of a device's operation while maintaining the ability to resolve fine details (far left). A high-resolution, analog-like scope display with 32 shades of gray helps you easily identify waveform irregularities (near left).

Selection Guide for Agilent Mixed-signal Oscilloscopes

	54832D Infiniium	54831D Infiniium	54830D Infiniium	54642D Portable	54641D Portable	54622D Portable	54621D Portable
Bandwidth	1 GHz	600 MHz	600 MHz	500 MHz	350 MHz	100 MHz	60 MHz
Channels scope+timing	4+16	4+16	2+16	2+16	2+16	2+16	2+16
Sampling	4 GSa/s	4 GSa/s	4 GSa/s	2 GSa/s	2 GSa/s	200 MSa/s	200 MSa/s
Maximum memory	Up to 16 M	Up to 16 M	Up to 16 M	8 M	8 M	4 M	4 M
MegaZoom	Yes	Yes	Yes	Yes	Yes	Yes	Yes
Special features	Infiniium's Windows-based interface gives you unparalleled ease of use for both scope and logic channels. Powerful triggering, measurements, and math functions make this the scope of choice for embedded applications. LAN and Web connectivity let you share information easily and control the scope remotely.			High-definition display with 32 shades of gray to give a clear analog-like view of critical waveforms. Familiar knob-based controls for both scope and logic channels helps you put these scopes to work right out of the box. Serial triggering simplifies tracking down CAN, I ² C, SPI, USB and other serial-bus problems. IntuiLink software simplifies PC connectivity.			
Description	For high-performance 32-bit embedded applications with high-speed logic	For 32-bit applications with logic; ~2 ns edge speeds and 4 scope channels	For DSP-based systems requiring extended analysis and deep memory	For higher-speed embedded and DSP applications	For medium-speed embedded applications up to 50 MHz	For 8- and 16-bit micro-controller applications	The lowest-cost MSO; ideal for education and industrial applications
Notes	Standard memory is 4 M, options extend up to 16 M.			IntuiLink software is provided at no cost. Scopes have built-in parallel and RS-232 IO. GPIB is an extra-cost option.			

Quality connections for confident measurement results

- *Passive probes for day-to-day usage*
- *Active probes for high bandwidth applications*
- *Differential probes*
- *Current probes*
- *High-voltage probes*
- *Cables and adaptors*



Whether you need the high bandwidth and low loading of an active probe, an easy way to connect to ICs or a probe to measure high voltages, there's a wide selection of high-performance acces-

sories for your Agilent Infiniium oscilloscope. Information sharing is supported with connectivity accessories such as LAN cables and interface modules. In addition, Agilent oscilloscopes are

supported with a full line of Testmobiles as well as accessories for rack mounting and transportation.

Selection Guide for Agilent Oscilloscope Probes and Accessories		
Type of accessory	Key features	Best for...
Passive probes	<ul style="list-style-type: none"> • small, light probe tip • probing handle to make handheld probing easy 	Accurate, low-cost day-to-day usage
Active probes	<ul style="list-style-type: none"> • up to 2 GHz probe bandwidth • minimal loading on DUT gives the most accurate insight into device responses 	High-accuracy measurements on high-frequency signals
Differential probes	<ul style="list-style-type: none"> • over-voltage protection circuitry • variety of coupling modes • low dc thermal drift 	<ul style="list-style-type: none"> • differential signal between two separate signals • "floating" (no ground) signals • low-voltage signals in the presence of DC voltage
High-voltage probes	Safely measure voltages up to 15 kV	Safely measures high-voltage signals
Current probes	<ul style="list-style-type: none"> • hall-effect (non-active) connection to DUT • low phase shift • high sensitivity 	<ul style="list-style-type: none"> • measurement and analysis of current waveforms and harmonics • power quality measurements
Surface-mount probes	<ul style="list-style-type: none"> • safe (no shorting) and easy connection to surface-mount ICs • mechanically non-invasive contact • easy connection for multiple probes 	Accurate measurement of surface-mount devices
Testmobile scope carts	Durable, ergonomic design	Easy transport of your shared scope

Confident measurements start with quality accessories



- **Ensure high signal integrity throughout the measurement path**
- **Find connectors and other accessories on our Web site designed specifically for your instruments**
- **Search for model number or browse by category and product features to quickly find what you need**

Complete your measurement solution with reliable connectors, cables and other accessories. Whether you're designing a complex RF or digital system or simply need a new lead set for your multimeter, Agilent accessories ensure a quality signal path that won't compromise your measurements.

RF and microwave accessories

If your designs depend on reliable, repeatable RF and microwave measurements, make sure your accessories aren't degrading overall measurement quality. Agilent attenuators, switches, adapters and cables deliver dependable results at competitive prices.



The Agilent N1810/1/2 latching coaxial switches combine extreme reliability—a minimum of 5 million guaranteed switching cycles—with the widest range of performance options available today.

Digital design and test accessories

Agilent scope and logic analysis probes and connectors are up to the challenge of today's fast components and complex chip packages. Choose from lead sets, SMD clips and unique probing solutions for high-density PQFP and TQFP packages.



Make sure you're measuring your circuit and not your scope probe. The Agilent 1156/7/8A active probes (1.5, 2.5, 4.0 GHz) for Infiniium scopes combined with the Agilent 54846B Infiniium scope offer a full 2.25 GHz of system bandwidth, giving accurate insight into your high-speed devices.

Basic instrument accessories

We offer a complete line of scope probes, DMM accessories and quality cables for dependable test connections. Choose from metrology, instrument and general-purpose cables to balance your financial and technical requirements.

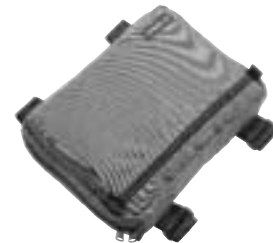

Keep your cables, power cords and manuals safe and handy with the Agilent 34161A pouch. The 34161A fits on top of the Agilent 34401A and 34420A multimeters, 34970A data acquisition/switch unit and most other 2U-high, half-rack-wide Agilent instruments.

Flexible precision, even as new standards emerge

- **Frequency range up to 6 GHz**
- **Wide RF modulation bandwidth, excellent dynamic range and EVM**
- **64 megasample (320 megabyte) volatile baseband memory**
- **1.2 gigasample (6 gigabyte) non-volatile waveform storage**
- **New capabilities: fading, waveform streaming and digital I/Q outputs**



The Agilent E4438C ESG vector signal generator provides excellent analog performance with level accuracy, output power, spectral purity, AM, FM, ϕ M, pulse, and a highly configurable architecture that is ideal for general purpose research and development as well as manufacturing or troubleshooting applications.

It sets a new level of performance by offering exceptional baseband signal generation operation. Its wide RF modulation bandwidth, fast sample rate, and large memory are key for evaluating the performance of 2.5G, 3G, and broadband wireless communications systems and components. A wide range of digital modulation (PSK, QAM, FSK, MSK)

capabilities include standards-based formats such as 802.11a/b/g, *Bluetooth*, W-CDMA, cdma2000, 1xEV-DO, EDGE, GSM, TD-SCDMA and more.

An expanded set of capabilities including fading, waveform streaming, and digital I/Q outputs are available when the E4438C is used with the new Baseband Studio products.

Agilent E4438C ESG Vector Signal Generator	
Frequency range	250 kHz to 1, 2, 3, 4, 6 GHz
Output power	+17 to -136 dBm
Level accuracy	± 0.5 to 1.5 dB
SSB phase noise (20 kHz offset)	-134 dBc (at 1 GHz)
Harmonics	< -32 dBc
Spurious	< -62 to < -80 dBc
Switching speed	< 9 ms
Jitter (@ 622 MHz, 5 MHz BW)	33 μ UI
Modulation BW	160 MHz
Sample rate	100 MHz
I/Q resolution	16-bit
Volatile memory	64 megasamples (320 MB)
Non-volatile memory	1.2 gigasamples (6 GB)
Modulation formats	W-CDMA, cdma2000, 1xEV-DO, 1xEV-DV, TD-SCDMA (TSM), CDMA, GSM, EDGE, WLAN (802.11a/b/g), <i>Bluetooth</i> , GPS, Enhanced Multitone, AWGN calibrated noise, AM, FM, ϕ M, pulse
Main attributes	<ul style="list-style-type: none"> • Compatible with Baseband Studio for fading • Compatible with Baseband Studio for streaming • Digital I/Q outputs with Baseband Studio digital signal interface module • LAN connectivity • Differential and single-ended I/Q outputs

Verify your designs practically anywhere: bench, line or field



- **Fast sweeps and measurements**
- **Continuously phase-locked synthesizer**
- **Application focused measurements for GSM, Bluetooth and more**

ESA-L: Affordable speed and accuracy

The Agilent ESA-L series provides basic spectrum analysis with the speed and accuracy to meet your needs. These affordable, fully synthesized analyzers are available in three frequency ranges: 1.5 GHz, 3.0 GHz and 26.5 GHz. They feature fast 4 millisecond RF sweeps and 30 measurement-per-second updates to the display or through the GPIB interface. For fieldwork, these rugged, portable analyzers feature a rubber-encased frame and

a weather-resistant front panel that allows operation in rain and high humidity. Continuous background alignment ensures accurate measurements, even when the outside temperature varies. A snap-on, rechargeable battery option enables cordless operation for up to 1.9 hours.

ESA-E: Flexible for the future

To help keep you on the leading edge, the Agilent ESA-E series offers a constantly

expanding set of features and measurement capabilities. Its six-slot card cage is a flexible measurement platform that lets you choose the performance you need now and easily upgrade later. You can also customize the ESA-E to meet specific testing requirements. Measurement personalities, downloaded into the analyzer's memory, transform the ESA-E into a focused solution for applications such as phase noise, GSM/GPRS, cdmaOne, *Bluetooth* and modulation analysis.

Agilent ESA Series Spectrum Analyzers

	ESA-L series E4411/03/08B	ESA-E series E4401/02/04/05/07B
Frequency range Standard	9 kHz to 1.5, 3.0 or 26.5 GHz	30 Hz ⁽¹⁾ to 1.5, 3.0, 6.7, 13.2 or 26.5 GHz ⁽²⁾
Resolution BW range	1 kHz to 5 MHz	1 Hz ⁽¹⁾ to 5 MHz
Dynamic range (maximum third-order)	83 dB/83 dB/82 dB	109 dB/108 dB/108 dB/108 dB/108 dB ⁽¹⁾
Sensitivity Displayed average noise level (DANL)	-117 dBm	-150 dBm ^(1,4) or -166 dBm ^(1,3,4)
Phase noise at 1 GHz at 10 kHz offset at 10 MHz offset	-90 dBc/Hz	-90 dBc/Hz -137 dBc/Hz ⁽¹⁾
Accuracy Overall amplitude accuracy Span accuracy Frequency accuracy	±1.1 dB (9 kHz to 3 GHz) ±1.0% ±2,001 Hz (at 1 GHz)	±1.0 dB (9 kHz to 3 GHz) ±0.5% ±101 Hz (at 1 GHz)
Speed Minimum RF sweep Minimum zero-span sweep Local measurement rate	4 ms 4 ms ≥28 meas/second ⁽⁴⁾	1 ms 25 ns ⁽¹⁾ ≥40 meas/second ⁽⁴⁾

⁽¹⁾ Optional

⁽²⁾ To 325 GHz with external mixing

⁽³⁾ With optional built-in preamp

⁽⁴⁾ Nominal

Ready for new generation, multiport, and differential RF devices

- **2, 3, or 4 built-in test ports with full port calibration**
- **Multiport measurements as fast as 9.6 μ s/point**
- **Balanced measurements to interpret mixed-mode S-parameters**
- **Matching-circuit simulation and port-characteristic impedance conversion**

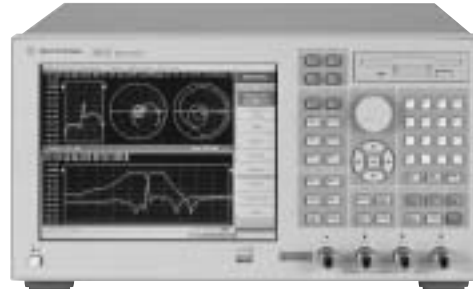

New-generation wireless equipment depends on advanced RF components from duplexers and couplers to differential SAW filters and amplifiers. Fast, accurate testing is crucial—and Agilent's ENA series network analyzers offer comprehensive measurement capabilities for advanced multiport devices.

The Agilent E5070B (3 GHz) and E5071B (8.5 GHz) offer 2, 3, or 4 test ports for simultaneous measurement of all signal paths in components with up to 4 ports.

This minimizes the number of sweeps required for multiport S-parameter measurements and helps increase test throughput. Built-in balanced measurements, matching-circuit simulation and port-characteristic impedance conversion all help reduce the overall cost of test.

The ENA series also accelerates test-system development and expands your customization capabilities. Built-in Visual Basic® for Applications (VBA) lets you develop test programs in the ENA series,

or import Visual Basic programs from an external PC. You can even create a custom user interface that uses a touch screen (optional) on the 10.4" LCD display.

On the production line, the ENA's excellent measurement accuracy improves test quality and repeatability. And with wide dynamic range and very low trace noise, the ENA series offers performance that will meet testing needs today and into the future.

Selection Guide for Agilent ENA Series RF Network Analyzers

	E5070B	E5071B
Frequency range	300 kHz to 3 GHz	300 kHz to 8.5 GHz
Number of ports	2, 3 or 4	2, 3 or 4
System dynamic range at test port	120 dB, 3 MHz to 1.5 GHz 122 dB, 1.5 GHz to 3 GHz	120 dB, 3 MHz to 1.5 GHz 122 dB, 1.5 GHz to 4 GHz 118 dB, 4 GHz to 6 GHz 113 dB, 6 GHz to 7.5 GHz 106 dB, 7.5 GHz to 8.5 GHz
Power at test port	-15 dBm to 10 dBm w/o attenuator -50 dBm to 10 dBm w/ attenuator	-15 dBm to 10 dBm w/o attenuator -50 dBm to 10 dBm w/ attenuator
Trace noise, 3 kHz BW	0.001 dB rms, 3 MHz to 3 GHz	0.001 dB rms, 3 MHz to 4.25 GHz 0.003 dB rms, 4.25 GHz to 7.5 GHz 0.005 dB rms, 7.5 GHz to 8.5 GHz

Visual Basic is a registered trademark of Microsoft Corporation in the U.S. and/or other countries.

The power-meter solution for affordable CW and average power measurements



- *Fast measurement speed over the GPIB (up to 200 readings/second with E-Series sensors)*
- *Code compatible with the 436A and 437B (E4418B) and 438A (E4419B)*
- *Operates with all 8480 and E-Series power sensors (except E9320 peak and average sensors)*

See table on bottom of page for product specifications.

 [For complete details, visit www.agilent.com/find/bi37am03](http://www.agilent.com/find/bi37am03)

EPM-P Series Power Meters

The power-meter solution for wireless 3G, radar and pulse power measurements



- *Peak, average, peak-to-average ratio and time-gated power measurements*
- *Analyzer software for complete pulse and statistical analysis on a PC or laptop*
- *Fast measurement speed over the GPIB (up to 1,000 corrected readings/second)*

Model No.	No. of channels	Frequency range ⁽¹⁾	Power Range ⁽¹⁾				Measurement speed with E-Series sensors	Standard interfaces
			E-Series E9320 sensors	E-Series E9300 sensors	E-Series CW sensors	8480 Series sensors		
E4416A	1	9 kHz to 110 GHz	-65 dBm to +20 dBm	-60 dBm to +44 dBm	-70 dBm to +20 dBm	-70 dBm to +44 dBm	Up to 1,000 readings/sec with E9320 sensors	GPIB, RS-232 and RS-422
E4417A	2	9 kHz to 110 GHz	-65 dBm to +20 dBm	-60 dBm to +44 dBm	-70 dBm to +20 dBm	-70 dBm to +44 dBm	Up to 1,000 readings/sec with E9320 sensors	GPIB, RS-232 and RS-422
E4418B	1	9 kHz to 110 GHz	N/A	-60 dBm to +44 dBm	-70 dBm to +20 dBm	-70 dBm to +44 dBm	Up to 200 readings/sec	GPIB, RS-232 and RS-422
E4419B	2	9 kHz to 110 GHz	N/A	-60 dBm to +44 dBm	-70 dBm to +20 dBm	-70 dBm to +44 dBm	Up to 100 readings/sec on each channel	GPIB, RS-232 and RS-422

⁽¹⁾ Sensor dependent

 [For complete details, visit www.agilent.com/find/bi37bm03](http://www.agilent.com/find/bi37bm03)

Cut the time required for successful instrument-PC connectivity

- **One-stop access for connectivity information: code samples, white papers, application notes and more**
- **Downloads for instrument drivers and IO**
- **More than 700 instrument and software manuals**
- **Peer-to-peer discussion forums**

Have you ever spent too much time getting your PC and test equipment to communicate; searched endlessly for drivers on the web; wished you could find the instrument manual you need; or needed help solving your connectivity problem?

The new Agilent Developer Network is the one-stop resource to support your connectivity needs. You can download drivers, IO, example code and call for personal support. Focus on your tasks, not on your connections – join ADN today!



Selection Guide for Agilent Developer Network (ADN)

Customized website	✓
Downloads	✓
Knowledge library	✓
Discussion forums	✓
T&M software product manuals	✓
Instrument manuals	✓
Scheduled CD shipments	✓
ADN update manager	✓
Expanded ADN web content	✓
Application and product notes	✓
T&M software product updates	✓
Price	Free

Software tools for every measurement automation need



- Choose from a complete set of software tools, from no-programming IntuiLink to a test automation environment
- Save effort with IO libraries and drivers that work with the software tools and Agilent equipment
- Choose from a range of development environments, from graphical to Microsoft open-standard-based

If you need to connect your test equipment to a PC and automate your measurements – whether your test code needs are simple or complex – this set of software tools has what you need.

For simple, fast, no-programming connections to siphon instrument data into Excel or Word, there's IntuiLink. For easy graphical programming to make measurements, there's VEE.

For development of test system software using Visual Studio .NET, there's T&M Programmers Toolkit.

Selection Guide for Test & Measurement Software				
Product	Description	Used in	Features at a glance	Best for
T&M Programmers Toolkit	Test code development program integrated into Visual Studio .NET	<ul style="list-style-type: none"> • Design characterization • Design validation • Manufacturing 	<ul style="list-style-type: none"> • Instrument ID and communication • Test code debugging • Data collection and analysis 	Writing reusable programs from Microsoft's standard Visual Studio .NET environment
VEE	Graphical instrument programming environment	<ul style="list-style-type: none"> • Data acquisition • Design • Low volume manufacturing test 	<ul style="list-style-type: none"> • Intuitive graphical development environment • Powerful analysis and visualization • Standards friendly with support for over 10 different environments 	Creating programs to acquire data in a graphical environment
IntuiLink	Toolbar add-ins for MS Word and Excel	<ul style="list-style-type: none"> • Early stages of design 	No-programming connection to acquire instrument data into Excel, Word	Simple data acquisition needs

Simplified connectivity over GPIB, USB and LAN

- **Easy access and control of GPIB instruments**
- **Support of industry standards – IEEE 488, USB or Ethernet**
- **VISA I/O Libraries provide backwards compatibility**
- **High throughput solutions up to 900 KB/s**
- **Connectivity suites combine the hardware and software to quickly and easily automate your tests**



Directly connect your test-and-measurement instruments to your PC or network in several different ways. For the fastest and easiest connections, Agilent converters let you take advantage of USB and LAN – the standard IO already available in your computer.

The USB/GPIB interface offers a direct connection from the USB port on your laptop or desktop PC to GPIB instruments from any vendor. There are no switches to set or PC cards to install.

For benchtop or system applications, the LAN/GPIB gateway provides remote access and control of GPIB instruments via 10BASE-T or 100BASE-Tx networks; enabling resource sharing, global project communications and remote access to instruments. Or if you prefer, the High Performance GPIB card plugs into the backplane of your computer and provides high system throughput.

The Agilent connectivity solutions offer direct connection to your PC using stan-

dard interfaces –GPIB, USB, or LAN. The interface includes hardware and Agilent VISA/SICL IO Libraries software. The VISA software offers backwards compatibility so that exiting VISA programs work with a simple reconfiguration.

Connectivity suites combine the hardware and software needed to quickly and easily automate your tests. See page 39.

Selection Guide for GPIB Cards and Converters				
	GPIB Converters		GPIB Plug-in Cards	
	82357A	E5810A	82350B	82341C
Description	USB/GPIB Interface connects to USB port on computer	LAN/GPIB Gateway provides remote access and control of GPIB instruments	PCI High-Performance GPIB Card	ISA High-Performance GPIB Card
Operating system	Windows 98 (SE)/Me/2000/XP	Windows 98 (SE)/Me/NT/2000/XP	Windows 98 Me/NT/2000/XP	Windows 95/98/NT/2000
IO libraries	VISA/SICL	VISA/SICL	VISA/SICL	VISA/SICL
Interface	USB 1.1	10BASE-T/100BASE-Tx	IEEE 488, 5V PCI	IEEE 488, ISA
Max speed	750 KB/s (with large block transfers)	N/A	900 KB/s	750 KB/s

Note: With the standard IO Libraries, these GPIB cards and converters work with many of the standard languages and applications.

For more information on Agilent Technologies products, applications or services, please contact your local Agilent office. Offices are arranged alphabetically by region.

The complete listing is available at:
www.agilent.com/find/contactus

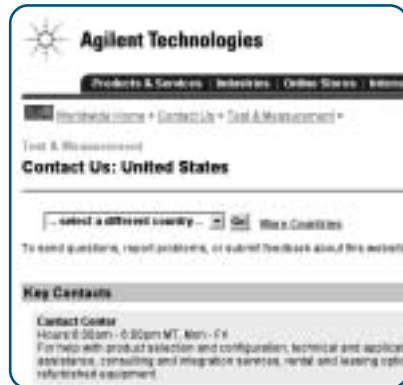

Americas

United States

Tel: (800) 452-4844
Fax: (888) 900-8921

Canada

General Inquiries
Tel: (877) 424-4536

Product Information
Tel: (877) 894-4414
Fax: (888) 900-8921

Latin America

Headquarters
Tel: (305) 269-7500
or Toll Free: (877) 4AGILENT
Fax: (305) 269-7599
Fax: (305) 269-7558

Argentina

Tel: (54 11) 5811 7115
Fax: (54 11) 5811 7287

Brazil

Tel: (55 11) 4197 3600
Fax: (55 11) 4197 3800
E-mail: tmobrasil@agilent.com

Mexico

Tel: (01800) 506 4800
Fax: (52 55) 5081 9467
E-mail: linea_directa@agilent.com

Asia Pacific

Australia

Tel: 1-800-629-485
Fax: 1-800-142-134
E-mail: tm_ap@agilent.com

China

Tel: 800-810-0189
Fax: 800-820-2816
E-Mail: tm_asia@agilent.com

Hong Kong

Tel: 800-930-871
Fax: (852) 2506-9233
E-mail: tm_ap@agilent.com

India

Tel: 1-600-112-929
Fax: 000-800-650-1101
or 1-600-113-035
E-mail: tm_ap@agilent.com

Japan

Tel: (81) 426 7832
Fax: (81) 426 7840
E-mail: contact_japan@agilent.com

Korea

Tel: (82-2) 2004-5004
or 080-769-0800
Fax: (82-2) 2004-5115
E-mail: korea_call@agilent.com

Malaysia

Tel: 1-800-888-848
Fax: 1-800-801-664
E-mail: tm_ap@agilent.com

Singapore

Tel: 1-800-375-8100
 Fax: (65) 6836-0252
 E-mail: tm_ap@agilent.com

Taiwan

Tel: 0800-047-866
 Fax: 0800-286-331
 E-mail: tm_asia@agilent.com

Thailand

Tel: (66-2) 268-1345
 or 1-800-226-008
 Fax: (66-2) 268-1346
 E-mail: tm_ap@agilent.com

Other Asia-Pacific Countries

Tel: (65) 6375-8100
 Fax: (65) 6836-0252
 E-mail: tm_ap@agilent.com

Europe and Middle East**Austria**

Tel: 0820 87 44 11
 Fax: 0820 87 44 22
 E-mail:
 contactcenter_austria@agilent.com

Belgium

Tel: +32 (0)2 404-9340
 Fax: +32 (0)2 404-9395
 E-mail:
 contactcenter_benelux@agilent.com

Denmark

Tel: +45 70 13 15 15
 Fax: +45 45 58 23 30
 E-mail:
 kundeservice_danmark@agilent.com

Finland

Tel: +358 (0)10 855 2100
 Fax: +385 (0)10 855 2923
 E-mail: asiakaspalvelu@agilent.com

France

Tel: 0825 010 700
 Fax: 0825 010 701
 E-mail:
 contactcenter_france@agilent.com

Germany

Tel: 01805 24 63 33
 Fax: 01805 24 63 36
 E-mail:
 contactcenter_germany@agilent.com

Ireland

Tel: +353 1890 924 204
 Fax: +353 1890 924 024
 E-mail:
 contactcenter_ireland@agilent.com

Italy

Tel: +39 02 92 60 8484
 Fax: +39 02 92 10 4069
 E-mail: contactcenter_italy@agilent.com

Luxembourg

Tel: +32 (0)2 404-9340
 Fax: +32 (0)2 404-9395
 E-mail:
 contactcenter_benelux@agilent.com

Netherlands

Tel: +31 (0)20 547 2111
 Fax: +31 (0)20 547 2190
 E-mail:
 contactcenter_benelux@agilent.com

Spain

Tel: +34 91 631 3300
 Fax: +34 91 631 3301
 E-mail: contactcenter_spain@agilent.com

Sweden

Tel: 0200 88 22 55
 Fax: +46 (0)8 506 48616
 E-mail: kundcenter_sverige@agilent.com

Switzerland

Tel: 0800 80 53 53
 Fax: (0)1 272 7373 (German)
 Fax: 022 567 5314 (Italian)
 Fax: 022 567 5313 (French)
 E-mail:
 contactcenter_switzerland@agilent.com

United Kingdom

Tel: +44 (0)7004 666666
 Fax: +44 (0)7004 444555
 E-mail: contactcenter_uk@agilent.com

Israel

Tel: +972 3 6892 500
 Fax: +972 3 6892 501
 E-mail: contactcenter_israel@agilent.com

Russia

Tel: +7 095 797 3900
 Fax: +7 095 797 3901
 E-mail: contactcenter_russia@agilent.com

Distributors Europe

Belarus

DMT Electronics
Tel: +375-172 096341
Fax: +375-172-28 55 23

Bulgaria

Test Solutions EOOD
Tel: +359 2 969 6060
Fax: +359 2 969 6070

Croatia

LPC d.o.o.
Tel: +385 161 13 411
Fax: +385 161 58 467

Czech Republic

H TEST a.s.
Tel: +420 2 353 65 207
Fax: +420 2 353 63 893

Greece

G-Systems
Tel: +302 107 56 90 65
Fax: +302 107 56 40 20

Greece

Netscope Solutions SA
Tel: +302 102 724 107
Fax: +302 102 711 999

Hungary

MEDEXPERT
Tel: +36 1 250 4490
Fax: +36 1 250 3795

Kazakhstan

Computer Service
Tel: +7 3272 582 020
Fax: +7 3272 583 505

Lithuania

Lokmis
Tel: +3705 2151 895
Fax: +370 5 2151 746

Norway

4Test AS
Tel: +47 67101080
Fax: +47 67101081

Poland

AM Technologies Polska
Tel: +48-22-6081440
Fax: +48 22 6081444

Portugal

CPCis
Tel: +351 21 4706200
Fax: +351 21 4706290

Romania

S.C. TELEPRECISION SA
Tel: +401 335 7710-11
Fax: +401335 7712

Serbia & Montenegro

IBIS Instruments
Tel: +381 11 319 31 57
Fax: +381 11 319 34 06

Slovakia

HTest
Tel: +421 48 4324 350
Fax: +421 48 4324 353

Slovenia

Avektis d.o.o.
Tel: +386 1 436 37 00
Fax: +386 1 436 02 20

Ukraine

UNITEST LTD
Tel: +380 44 235 78 12
Fax: +380 44 235 51 75

Uzbekistan

ABM Worldwide Technologies
Tel: +998 71 132 0871/4
Fax: +998 71 120 6485

Distributors Middle East & Africa

Algeria

RTI Algerie

Tel: +213-21-693295

Fax: +213-21-606298

Bahrain

Al Moyad Telecom

Tel: +973-727 123

Fax: +973-729 629

Egypt

Advance Technologies Company (ATC)

Tel: +202 404 23 06

Fax: +202 403 4384

Jordan

S.M.S.

Tel: +9626 462 49 07

Fax: +9626 62 82 58

Kuwait

Future Communications Company W.L.L.

Tel: +965 243 2555

Fax: +965 243 1926

Lebanon

Computer Information Systems

Tel: +961-4-405413

Fax: +961-4-525-181

Morocco

Sicotel

Tel: +212 223 122 70

Fax: +212 223 165 45

Nigeria

Management Information Systems

Tel: +234 1 269 13 07

Fax: +234 1 269 3419

Oman

Imtac LLC

Tel: +968 70 7727

Fax: +968 79 7709

Qatar

Intertec Group W.L.L.

Tel: +974 4696 7000

Fax: +974 4696 926

Saudi Arabia

Al Faisaliah Medical & Measurement.

Tel: +966 1 462 42 66

Fax: +966 1 462 44 04

Saudi Arabia

Baud Telecom Co.

Tel: +966 5 468 8912

Fax: +966 1 218 0330

South Africa

Concilium Technologies

Tel: +2712 678 9200

Fax: +2712 665 4160

Tunisia

Tunisie Test et Mesure

Tel: +216 71 237 123 or 237 544

Fax: +216 71 235 048

Turkey

SPARK OLCUM TEKNOLOJILERI

Tel: 90 312 466 8212

Fax: 90 312 468 8449

United Arab Emirates

EMITAC Ltd

Tel: +971 2 671 08 00

Fax: +971 2 671 10 59

Prices and payment

Please contact your Agilent Technologies sales office or authorized distributor for the latest prices and information on payment terms specific to your country.

Selection guide errors

Agilent reserves the right to correct printing errors.

Shipping

Free surface delivery

Prices include regular surface freight delivery by a carrier of Agilent's choosing.

Agilent Technologies' Test and Measurement Support, Services and Assistance

Agilent Technologies aims to maximize the value you receive, while minimizing your risk and problems. We strive to ensure that you get the test and measurement capabilities you paid for and obtain the support you need. Our extensive support resources and services can help you choose the right Agilent products for your applications and apply them successfully. Every instrument and system we sell has a global warranty. Support is available for at least five years beyond the production life of the product. Two concepts underlie Agilent's overall support policy: "Our Promise" and "Your Advantage."

Our Promise means your Agilent test and measurement equipment will meet its advertised performance and functionality. When you are choosing new equipment, we will help you with product information, including realistic performance specifications and practical recommendations from experienced test engineers. When you use Agilent equipment, we can verify that it works properly, help with product operation, and provide basic measurement assistance for the use of specified capabilities, at no extra cost upon request. Many self-help tools are available.

Your Advantage means that Agilent offers a wide range of additional expert test and measurement services, which you can purchase according to your unique technical and business needs. Solve problems efficiently and gain a competitive edge by contracting with us for calibration, extra-cost upgrades, out-of-warranty repairs, and on-site education and training, as well as design, system integration, project management, and other professional engineering services. Experienced Agilent engineers and technicians worldwide can help you maximize your productivity, optimize the return on investment of your Agilent instruments and systems, and obtain dependable measurement accuracy for the life of those products.

By Internet, phone or fax, get assistance with all your test and measurement needs.

On-line assistance:

www.agilent.com/find/assist

Warranty

As an expression of confidence that Agilent's products will continue to meet the high standards of reliability and performance that Agilent's customers expect, Agilent products carry the following limited warranty:

Agilent Technologies products are warranted against defects in materials and workmanship. If Agilent Technologies receives notice of such defects during the warranty period, Agilent Technologies shall, at its option, either repair or replace hardware products that prove to be defective.

All instruments in this selection guide are manufactured at sites that have been ISO-9002 certified and are CFC-free.

To provide the best service for you now and in the future, your call may be recorded.

Quickly analyze mixed-signal designs up to 1 GHz

NEW

- *View up to 20 analog and digital channels at once*
- *4 MB MegaZoom deep memory captures all system data*
- *Isolate events of interest with superior triggering*
- *Extensive connectivity and Web-based remote control makes sharing information easy*



***Introducing the lowest
cost 1-GHz DSO
and MSO available!***

The new Agilent 54830D series mixed-signal scopes combine the power of simultaneous analog and digital measurements with the intuitive operation of the Infiniium user interface. Even at bandwidths up to 1 GHz, you'll finally have a fast, easy way to view the complex interaction of up to 4 analog signals

and 16 digital signals. Plus, advanced MegaZoom technology delivers fast, usable and affordable deep memory for instantaneous response and sure capture of elusive details.

For complete specifications, options and pricing, visit www.agilent.com/find/mso.

www.agilent.com/find/products

Call your local Agilent sales office

Technical data and pricing subject to change.

For test and measurement inquiries, visit
www.agilent.com/find/contactus



Printed in U.S.A. May 31, 2003
© Agilent Technologies, Inc. 2003
5988-9465ENN